



bizhub PRESS C7000/C7000P/C6000

Technical Training Course

Welcome to the bizhub PRESS C7000/C7000P/C6000 Technical Training Course. This Course will cover Four Lessons of the bizhub PRESS C7000/C7000P/C6000 Engine Differences.

Engine Modules

To download these files, you must have [Adobe Acrobat](#) installed on your computer.

- [bizhub PRESS C7000 Workbook \(3.3 mb\)](#)
- [bizhub PRESS C7000 Workbook \(2.6 mb\)](#)

It should take you approximately 2-3 Hours to complete this course.



NARRATION:

Welcome to the bizhub PRESS C7000/C7000P/C6000 Technical Training Course. This WBT Course will cover Four Lessons covering the bizhub PRESS C7000/C7000P/C6000 Engine Differences. Please take the test after you have completed this course.

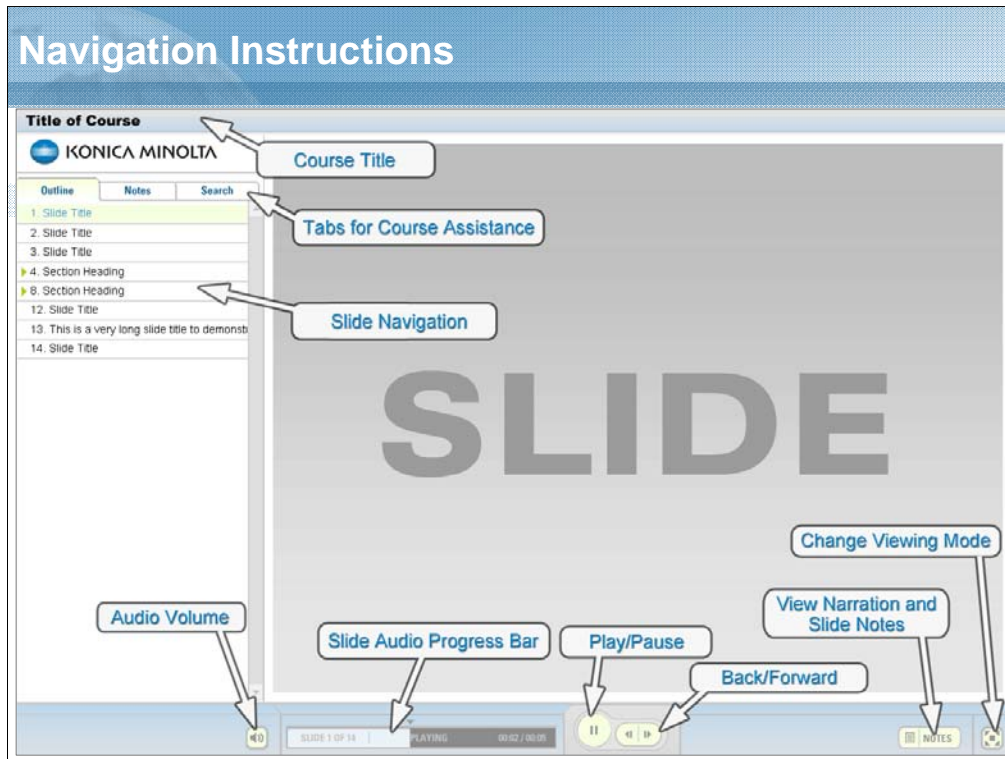

NARRATION:

These are the navigation instructions.

Course Objectives



In this course you should be able to:

1. Outline
2. Configuration/Operation
3. Field Service
4. ORU-M

NARRATION: On completion of this course, you should be able to Understand the Information in the Outline, Configuration, Operation, Field Service and the ORU-M Mode.

Lesson 1: Outline

Topics covered in the Lesson include:

- 1.1 Product Specifications
- 1.2 Lesson Review

NARRATION:

The following topics will be covered in this lesson.

1.1 Product Specifications

❖ Main Differences

Items	C7000/C7000P/C6000	C6501/C6501P/C65hc	Details
Continuous Copy Speed (A4)	C7000/C7000P: 71ppm C6000:60ppm	65ppm	Speed Increase
Continuous Copy Speed (8 1/2 x 11)	C7000/C7000P: 70ppm C6000: 60ppm	65ppm	Speed Increase
Sensitizing Method	8-beam Laser Writing Method	2-beam Laser Writing Method	Speed Increase, Higher-Resolution
Writing Resolution	1200 x 1200 dpi (equivalent to 3600 dpi x 1200 dpi)	600 x 600 dpi	Scanning is 600 dpi
DRAM	384 MB x 6	256 MB x 4	In addition to 4 ch of CMYK, 2 ch of preview and attribute
HDD	160 GB or more x 6	30 GB x 4	
USB	Type A x 3	Type B x 1	-
Parallel Port	Not Provided	Provided	-
Weight	Approx. 353 kg (C7000/C6000) Approx. 333 kg (C7000P)	Approx. 360 kg	C7000 does not include DF
Dimension	[Main Body + DF-622 + LU-202 + FS-612] : 2,150 (W) x 992.7 (D) x 1,478.2 (H) mm	[Main body + DF-609 + LU-202 + FS-607] : 2,139 (W) x 992 (D) x 1,414 (H) mm	-

[Product Specifications](#) 

NARRATION:

In this table are the main differences of the product specifications.

For additional details, refer to the attached PDF file.

1.2 Lesson 1 Review

Lesson 1

In this Lesson, you learned about:

1.1 Product Specifications

NARRATION:

In this lesson, you learned about the Product Specifications of the bizhub PRESS C7000 Series.

Lesson 2: Configuration/Operation

Topics covered in the Lesson include:

- | | |
|-----------------------------------|----------------------------------|
| 2.1 Overall Configuration | 2.12 Registration Section |
| 2.2 Interface Section | 2.13 Fusing Section |
| 2.3 Write Section | 2.14 Duplex Section |
| 2.4 Photoconductor Section | 2.15 Reverse/exit Section |
| 2.5 Charging Section | 2.16 Image Stabilization Control |
| 2.6 Developing Section | 2.17 Image Processing |
| 2.7 Toner Supply Section | 2.18 Power Source Section |
| 2.8 Intermediate Transfer Section | 2.19 Fan Control |
| 2.9 Toner Collection Section | 2.20 Counter Control |
| 2.10 Paper Feed Section | 2.21 Operation Panel |
| 2.11 Vertical Conveyance Section | 2.22 Lesson Review |

NARRATION:

The following topics will be covered in this lesson.

2.1 Overall Configuration (1/5)

❖ Main Differences

Items	C7000/C7000P/C6000	C6501	Details
Control Block Diagram	Extensively Changed Common with C8000	-	Extensively Changed High Quality, Image Stability
Process Speed	C7000/C7000P: 5 Types 315mm/s, 300mm/s, 225mm/s, 208mm/s, 150mm/s C6000: 3 Types 300mm/s, 208mm/s, 150mm/s	3 Types 300mm/s, 208mm/s, 150mm/s	Improvement of productivity
Sub Power Switch Installation Position	Top Right Corner on the Front Side of the Main Body	Toner Supply Section Top	Improvement of performance
Exterior Color	New texturing in solid blue (coatless)	Dedicated color	Changed to the new design same as the C8000

NARRATION:

This table covers the main differences of the overall composition.

2.1 Overall Configuration (2/5)

❖ Unit Differences Information

Items	C7000/C7000P/C6000	C6501	Details
Scanner Section	No change	-	-
Write Section	Change Common mechanism with the C8000	-	Higher Image Quality
Charging Section	No change	-	-
Toner Collection Section	No change	-	-
Vertical Conveyance Section	No change	-	-
Registration Section	No change	-	-
Duplex Section	No change	-	-
Image Processing Section	Change	-	Higher Quality, Image Stability
Operation Panel	Change	-	Larger Screen, adoption of Audio Guidance

NARRATION:

The Unit Differences for the C7000 Series is covered here and information is provided of the items that were not changed from the C6501 or that were changed from other models.

2.1 Overall Configuration (3/5)

❖ Control Block

- The Control of the Image Memory is unified on the Memory Control Board /1 (MCB1).
- In the case of the Optional HDD Unit (6 Hard Disks Drives are built in), one for each CMYK Data is connected to the Memory Control Board /1 (MCB1), one for preview is connected to the Memory Control Board /P (MCB/P), and one for attribute is connected to the Overall Control Board (OACB).
- For details of the Control Block Diagram, refer to the attached PDF file.

[Control Block Diagram](#) 

❖ Process Speed

- There are 5 types of Process Speeds for C7000/C7000P; 2 High Speeds, 2 Middle Speeds, and 1 Low Speed.
- There are 3 types of Process Speeds for the C6000; High Speed, Middle Speed, and Low Speed.
- For details of the Process Speeds , refer to the attached PDF Files.

[C7000/C7000P Process Speed](#) 

[C6000 Process Speed](#) 

NARRATION:

An overview of the changes for the control block and process speed are covered here.

2.1 Overall Configuration (4/5)

❖ Sub Power Switch

Sub Power Switch (SW2)



C7000/C7000P/C6000

Sub Power Switch (SW2)



C6501

NARRATION:

The installation position of the sub power switch was changed due to the change of the machine design.

2.1 Overall Configuration (5/5)

❖ Exterior Color

New texturing in Solid Blue (coatless)



C7000/C7000P/C6000



C6501

NARRATION:

The exterior color was changed to match the color of the other New Production Print Systems.

2.2 Interface Section

❖ Main Differences

Items	C7000/C7000F/C6000	C6501	Details
Parallel Port	Not provided	Provided	Cost reduction
Service Port (USB)	3 (Support Post of the Operation Panel Section)	1	Improvement of convenience

[Main Body Interface](#)



NARRATION:

Here are the changed items of the interface section.

For additional details, refer to the attached PDF file.

2.3 Write Section (1/2)

❖ Main Differences

Items	C7000/C7000P/C6000	C6501	Details
Write Unit	Common to all colors	Yellow, Magenta, Cyan: Common Black: Dedicated	Improvement of Service/Common with C8000
Resolution	1200 dpi	600 dpi	Improvement of Printing Quality
Laser	8 beams	2 beams	Improvement of Printing Speed
Maximum Scan Width	321 mm	318 mm	Specification Change

NARRATION:

This table covers the main differences of the Write Section overall composition. In the C7000 Series, 8-beams are now written by 1 scan of the laser.

2.3 Write Section (2/2)

❖ Configuration and Exposure Path

- The Writing Unit is common to all colors.
- 1-chip 8-beam Laser is used for the light source and it writes at a resolution of 1200 dpi.

[Exposure Path](#) 

NARRATION:

The writing unit is common to all colors, with a single-chip 8-beam laser source, with the resolution increased to 1200 dpi. To improve the Partial Magnification Correction, the adjustment mechanism was added not only to the Main Body but also in the Print Heads.

2.4 Photoconductor Section (1/2)

❖ Main Differences

Items	C7000/C7000P/C6000	C6501	Details
Drum Potential Sensor	Not provided	Provided	Control method change ->Use the IDC Sensor
Cleaning Blade	Material change	-	Improvement for Image Troubles (Marks on Drum)
Lubricant Application Roller	Material change	-	Improvement for Image Troubles (Marks on Drum)

NARRATION:

This table covers the changed items of the photoconductor section.

2.4 Photoconductor Section (2/2)

❖ Configuration

- Image Troubles (Marks on the Drum) was improved by changing the material of the Cleaning Blade and the Lubricant Application Brush.

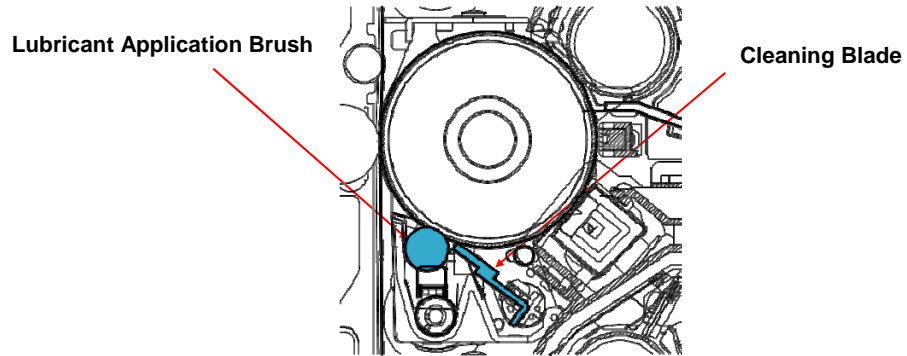

NARRATION:

Here is the configuration of the photoconductor section.

The materials of the cleaning blade and lubricant application brush were changed to prevent marks on drum.

2.5 Charging Section

❖ Main Difference

Item	C7000/C7000P/C6000	C6501	Details
Tilt Adjustment	Not Provided	Provided	Irregular Density has been improved with the New Write Units

NARRATION:

The Tilt Adjustment was removed and is no longer necessary with the New Write Units.

2.6 Developing Section (1/4)

❖ Main Differences

Items	C7000/C7000P/C6000	C6501	Details
Developing Bias (AC) Condition	Optimized	-	Quality Maintenance even with Drum Potential Sensor Abolishment
Developing Suction	Filter Box with Cyclone System	Normal Filter Box	Toner Collection amount is increased due to Improvement of Suction Power Extension of Filter Box Replacement Cycle
Developing Dust Proof Filter	Provided	Not Provided	For Light Shielding of Write Units Image Troubles (White Line/s) Prevention
Developing Fan	2	3	Specification Change
ORU	Relay Connector Larger	Non-Compliant	Improvement of Service Performance

- For details of the Developing Fan, refer to “2.19 Fan Control.”

NARRATION:

Here are the changed items in the developing section.

2.6 Developing Section (2/4)

❖ Filter Box

- The Suction Path/Power is improved by using the Cyclonic System provided in the Filter Box.
- Toner Collection amount is increased by the improvement of the Suction Power, and the Replacement Cycle is improved from every 200,000 prints to every 600,000 prints.

[Filter box](#)

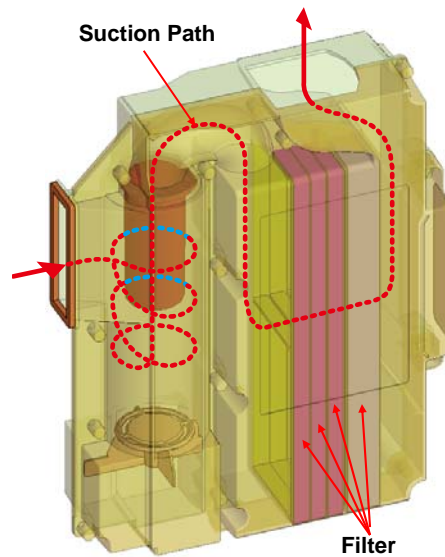

NARRATION:

The explanation of the [filter box](#) in the developing section is covered here.

A Cyclonic system was adopted for the suction path in the filter box because it provides greater suction power.

2.6 Developing Section (3/4)

❖ Developing Dust Proof Filter

- For the Light Shielding of the Write Unit and Image Troubles (White Lines) are prevented by the use of a new Developing Dust Proof Filter.

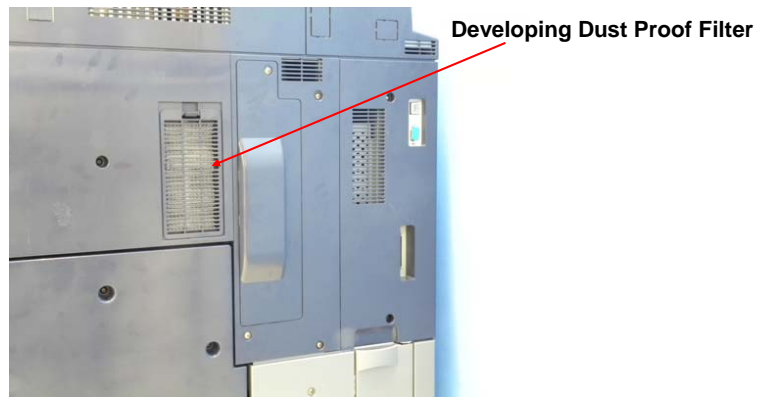

NARRATION:

The Developing dust proof filter was added to the developing section.

2.6 Developing Section (4/4)

❖ ORU

- By making the Relay Connector of each Developing Unit larger and changing the removal direction to the upper direction, the service performance is improved.

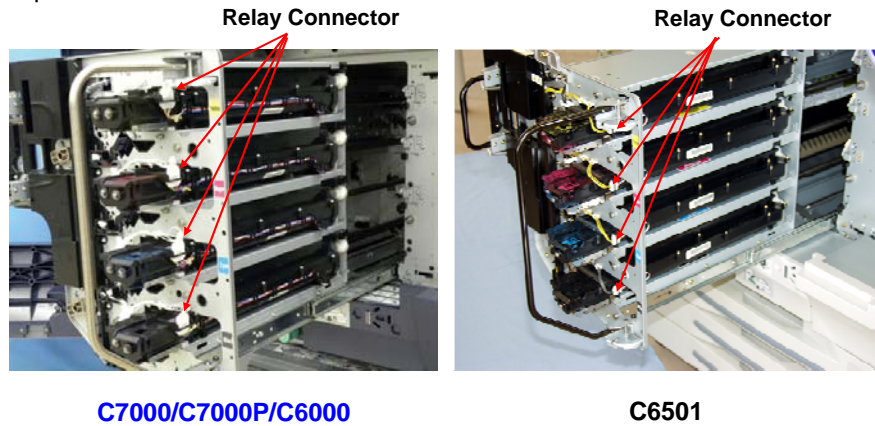

NARRATION:

To correspond with the ORU procedures, the relay connector of the developing unit was made larger and the removal direction was changed.

2.7 Toner Supply Section

❖ Main Differences

Items	C7000/C7000P/C6000	C6501	Details
Cap Section for the Toner Bottle	Enlarged Open/Close Angle	-	Improvement of replacing performance
Toner Bottle Insert Section	Dedicated Shape	-	Wrong Insertion Prevention, Improvement of Replacement Performance
Toner Capacity	Yellow, Magenta, Cyan: 600 g Black: 820 g	Yellow, Magenta, Cyan: 460 g Black: 690 g	Increases Printing Toner Yield

NARRATION:

In this table, the items that were changed in the toner supply section are covered.

2.8 Intermediate Transfer Section

❖ Main Difference

Item	C7000/C7000P/C6000	C6501	Details
Image Correction Unit	IDC Sensor	PGC Sensor	Stabilization of Density Detection Precision

NARRATION:

Here is the changed item in the intermediate transfer section.

2.9 Toner Collection Section

❖ Main Difference

Item	C7000/C7000P/C6000	C6501	Details
No changes	-	-	-

NARRATION:

There are no changes in the toner collection section.

2.10 Paper Feed Section

❖ Main Difference

Item	C7000/C7000P/C6000	C6501	Details
Bypass Tray	Option	Standard equipment	Corresponding to the diversification of the User's System Selection
ORU	Paper Feed Roller, Separation Roller	Non-compliant	Improvement of Service

NARRATION:

In order to correspond to the diversification of the user's system selection for the paper feed systems, the bypass unit was changed to an option.

2.11 Vertical Conveyance Section

❖ Main Difference

Item	C7000/C7000P/C6000	C6501	Details
No changes	-	-	-

NARRATION:

There are no changes in the vertical conveyance section.

2.12 Registration Section

❖ Main Difference

Item	C7000/C7000P/C6000	C6501	Details
No changes	-	-	-

NARRATION:

There are no changes item in the registration section.

2.13 Fusing Section (1/5)

❖ Main Differences

Items	C7000/C7000P/C6000	C6501	Details
Applied Power	Reinforced	-	Corresponding to A4 71ppm
Fusing Air Separation Control	Provided	Not Provided	Wrapping Jam Prevention of Thin Paper
ORU	Relay Connector Shape Change	Non-Compliant	Improvement of Removal Performance
Fusing Line Prevention	Provided	Not Provided	Prevention of Image Troubles (Fusing Lines)

NARRATION:

Here are the changes in the fusing section.

2.13 Fusing Section (2/5)

❖ **Applied Power Increased**

- To make 71 ppm possible for A4/Ltr Sized Paper, the Applied Power to the Fusing Unit was increased.

NARRATION:

The applied power was increased to support the fusing section due to the increase in speed to 71ppm for A4 and letter sized paper.

2.13 Fusing Section (3/5)

❖ Fusing Air Separation Control

- Prevents the type of Wrapping Jam of the Fusing Belt when printing on Thin Paper.
- It blows air from the Fusing Separation Fans /1 (FM7), /2 (FM8), and /3 (FM9) provided on the Upper Section of the Fusing Unit to assist the paper separating from the fusing belt.
- The execution of this control and the Air Speed Switchover (7 steps) of FM7, FM8, FM9 can be selected from the Operation Panel.

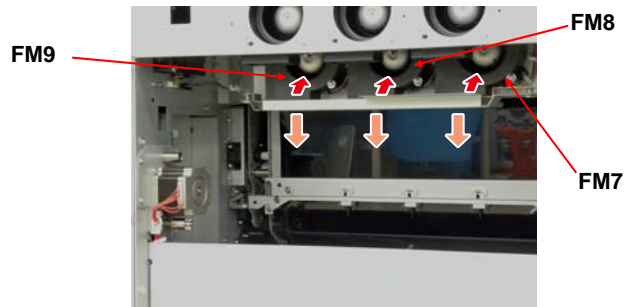

NARRATION:

To prevent thin paper from wrapping around the fusing belt, the fusing air separation mechanism was added.

It blows air from the fusing separation fan provided on the upper section of the fusing unit to assist the paper separating from the fusing belt.

2.13 Fusing Section (4/5)

❖ ORU

- The shape of the Relay Connector between the Fusing Unit and the Main Body is changed to the independent type that can be separated without removing the Cover of the Fusing Unit.
- Since the Relay Connector can be removed just by sliding the Fusing Unit, the removal performance is improved.



Relay Connector

NARRATION:

For the ORU Procedures and to shorten the disassembling time, the procedure to remove the fusing unit was changed.

2.13 Fusing Section (5/5)

❖ Fusing Line Prevention

- To prevent the Image Troubles (Fusing Lines) which occurs during Large Size Printing after Small Size Printing, the Fusing Unit can be selected from the two types as needed.
- The types of two Fusing Units can be distinguished by the Jumper Connector.
- The one with the Jumper Connected is designated for the Large Size Fusing Unit.

Jumper Connector

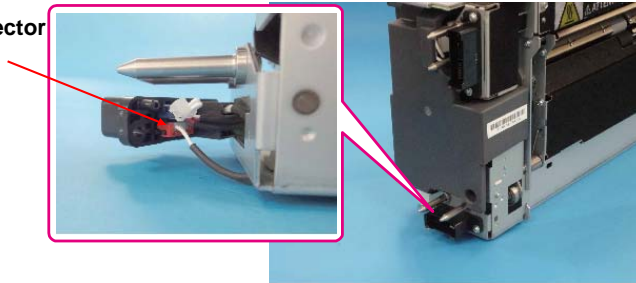

NARRATION:

To prevent image quality problems of a fusing line which occurs when printing large size documents after small printing sized documents, the fusing unit can be switched manually between the two types as needed.

2.14 Duplex Section

❖ Main Difference

Item	C7000/C7000P/C6000	C6501	Details
No changes	-	-	-

NARRATION:

There are no changes in the duplex section.

2.15 Reverse/Exit Section

❖ Main Difference

Item	C7000/C7000P/C6000	C6501	Details
Tucking Fan	2	3	Specification change

- For details of the Tucking Fan, refer to the PDF Link at “2.19 Fan Control.”

NARRATION:

The cooling performance of the tucking fan was evaluated and the number of fans were reduced to two.

2.16 Image Stabilization Control (1/5)

❖ Main Difference

Item	C7000/C7000P/C6000	C6501	Details
Image Stabilization Control	2 Types · Image Stabilization Batch Correction Control · Stabilization Control between images	1 Type	Due to process change

NARRATION:

Here are the changes for the image stabilization control.

There are now 2 types of image stabilization control; Image stabilization batch correction control and stabilization control between images.

2.16 Image Stabilization Control (2/5)

❖ Flow of Image Stabilization Control when Sub Power Switch is turned ON

- Image Stabilization when the Sub Power Switch is turned ON is the same as the C6501.

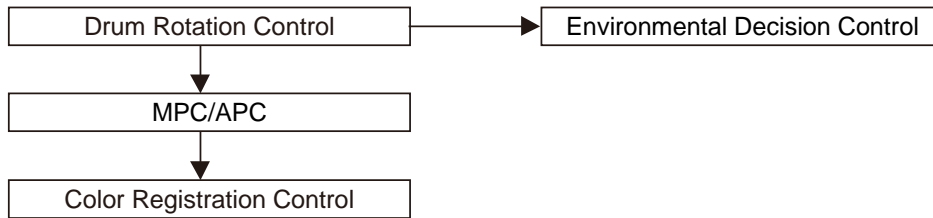

[Image Stabilization Control when Sub Power Switch is turned ON](#) 

NARRATION:

Here is the flow of the image stabilization control when sub power switch is turned ON.

The image stabilization flow is the same as the previous device.

After the color registration, image stabilization batch correction control and stabilization control between images are executed during the operation condition.

For details of the image stabilization, refer to the attached PDF file.

2.16 Image Stabilization Control (3/5)

❖ Flow of Image Stabilization Batch Correction Control

- It corrects the image density change caused by the change of the materials and process characteristics that come from being in a unused condition for long period, environmental temperature/humidity changes, and large number of continuous printing
- The TCR Sensor Process Speed Correction is a preparation for acquiring the correct value per process speed beforehand to prevent the loss of the Toner Density Control between process speeds.

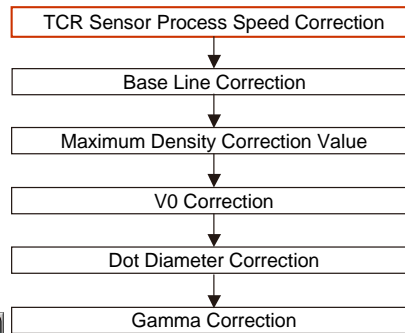

[Image Stabilization Batch Correction Control](#)



New item is designated by the Red Highlighted Frame

NARRATION:

Here is the flow of the image stabilization control during the image stabilization batch correction control.

This control corrects the image density changes caused by the change of the materials and process characteristic those are come from the system being in a unused condition for long period of time, along with environmental temperature and humidity changes, and large numbers of continuous printing.

For details of the image stabilization batch correction control, refer to the attached PDF file.

Вот последовательность операций управления стабилизацией изображения во время управления пакетной коррекцией стабилизации изображения.

Этот элемент управления корректирует изменения плотности изображения, вызванные изменением материалов и характеристик процесса, которые происходят из-за того, что система находится в неиспользованном состоянии в течение длительного периода времени, наряду с изменениями температуры и влажности окружающей среды и большим количеством непрерывной печати.

Подробнее о контроле пакетной коррекции стабилизации изображения см. В прилагаемом файле PDF.

2.16 Image Stabilization Control (4/5)

❖ Stabilization Control Between Images

- It is executed periodically when the Stability Priority Mode is selected.

* Types of Stabilization Control between images

- Dot Diameter Correction between images
- Stabilization Priority Periodic Adjustment
- Short gamma Correction

[Stabilization Control Between Images](#) 

NARRATION:

Image stabilization control between images is executed periodically when the stability priority mode is selected.

The Printing job is stopped to correct the image density and the color changes.

For additional details of the stabilization control between images, refer to the attached PDF file.

2.16 Image Stabilization Control (5/5)

❖ Other Image Stabilization Controls

- The following are an additional 2 types of Image Stabilization other than Image Stabilization Batch Correction Control and Stabilization Control Between Images.
 1. Charge Potential Automatic Adjustment
 2. Pre-agitation when left unused

[Other Image Stabilization Controls](#) 

NARRATION:

The following 2 types of image stabilization are in addition to the image stabilization batch correction control and the stabilization control between images.

For additional details, refer to the attached PDF file.

2.17 Image Processing Section (1/3)

❖ Main Differences

Items	C7000/C7000P/C6000	C6501	Details
Image Processing in the Scanner Section	Control board is changed	-	-
	Supporting 600 dpi	Supporting 600 dpi	Not changed/Not Applicable for the C7000P
Image Processing in the Write Section	Control board is changed	-	-
	Supporting 1200 dpi	Supporting 600 dpi	Improvement of Printing Quality

NARRATION:

Here are the main differences of the Image Processing Section. To increase the Improvement in Printing Quality the Image Processing in the Write Section, the C7000 series now supports writing at 1200 dpi.

2.17 Image Processing Section (2/3)

❖ Image Processing in the Scanner Section

- The Image Processing in the Scanner Section is almost same as that of the previous model.

[Image Processing in the Scanner Section](#) 

NARRATION:

Shown here is the Image Processing changes in the Scanner Section.

The Image Processing in the Scanner Section is almost same as that of the previous model.

For additional details, refer to the attached pdf file.

2.17 Image Processing Section (3/3)

❖ Image Processing in the Write Section

1. The resolution of the Write Section was changed to 1200 dpi from 600 dpi, and a change in the Image Processing Method.
2. To improve the Image Quality, the following new processes were added.
 - Change the Print Resolution to 1200 dpi
 - Data Processing Flow with 1200 dpi x 8 bit
 - Implementing Image Reproducibility by the Dot or FM Screen Processes
 - Clear reproduction of letters by the use of Outline Processing

[Image Processing in the Write Section](#) 

NARRATION:

The resolution of the Write Section was changed to 1200 dpi from 600 dpi, along with a change in the Image Processing Method.

To improve the Image Quality, the following new processes were added.

For additional details, refer to the attached pdf files.

2.18 Power Source Section (1/2)

❖ Main Difference

Item	C7000/C7000P/C6000	C6501	Details
Power Plug	Large-Current Type Supporting 4,400W	Normal Type Supporting 3,000W	Specification change

NARRATION:

The power plug was changed to a larger current type that will support up to 4400 Watts of power consumption.

2.18 Power Source Section (2/2)

❖ Power Plug Shape

C7000/C7000P/C6000



Europe, Asia/Pacific



North America

C6501



Area	Part No.	Model
Japan	A0G6N30A	2 poles (with grounding pole) insert plug 30A/250V
North America	A0G6N30E	NEMA L6/30 30A/250VAC
Europe Asia Pacific	A0G6N30F	PCE023-6 32A/220-250VAC
Australia	A0G6N30M	PDL 56P332 32A/250VAC

NARRATION:

The shape of the power plug was changed in accordance with the change of the rated current.

2.19 Fan Control

❖ Main Differences

Item	C7000/C7000P/C6000	C6501	Details
Fan Configuration	Fusing Separation Fans /1, /2, /3	-	Fusing Jam Prevention for Thin Paper
	Power Supply Cooling Fans /3, /4	-	Improvement of Cooling Performance for the Power Source Section

[Fan Configuration](#) 

NARRATION:

Fan configuration was changed in the Fusing and Power Supply Areas.

Refer to the attached PDF file for additional details.

2.20 Counter Control

❖ Main Differences

Items	C7000/C7000P/C6000	C6501	Details
Count Up Threshold of PM Counter	Cannot be changed	Can be changed with DIPSW	Specification Change
Each Counter Value	Calculated from Count Value per paper	Counted by each Counter	Specification Change
Count Up Threshold of Custom Sizes	Can be changed with Service Mode	Fixed	Specification Change

NARRATION:

The differences in the counter control is covered in this table.

2.21 Operation Panel

❖ Main Differences

Item	C7000/C7000P/C6000	C6501	Details
Type	Stand-Alone (Setting Position Arbitrary)	Arm-Fixed Mount Type	Specification Change
Monitor Size	15 inches	12 inches	Specification Change
Speaker	Provided	Not Provided	Specification Change
Service Ports	3 USB Type A	Not Provided	Specification Change
Operation Panel	Moved the electrical hardware	-	-

NARRATION:

Shown in this table are the Main Differences for the Operation Panel.

The Operation Panel can now be set at an Arbitrary Position, rather than being fixed, and is now larger and the display is easier to read.

The C7000 Operation Panel now has a vocal warning function and 3 USB Service Ports.

2.22 Lesson 2 Review

Lesson 2

In this Lesson, you learned about:

- | | |
|-----------------------------------|----------------------------------|
| 2.1 Overall Configuration | 2.12 Registration Section |
| 2.2 Interface Section | 2.13 Fusing Section |
| 2.3 Write Section | 2.14 Duplex Section |
| 2.4 Photoconductor Section | 2.15 Reverse/exit Section |
| 2.5 Charging Section | 2.16 Image Stabilization Control |
| 2.6 Developing Section | 2.17 Image Processing |
| 2.7 Toner Supply Section | 2.18 Power Source Section |
| 2.8 Intermediate Transfer Section | 2.19 Fan Control |
| 2.9 Toner Collection Section | 2.20 Counter Control |
| 2.10 Paper Feed Section | 2.21 Operation Panel |
| 2.11 Vertical Conveyance Section | 2.22 Lesson Review |

Narration:

In this lesson, you learned about the differences in the operation units of the bizhub PRESS C7000 Series.

Lesson 3: Field Service



Topics covered in the Lesson include:

- | | |
|---------------------------|------------------------------------|
| 3.1 Maintenance | 3.7 Software DIPSW |
| 3.2 Service Tool | 3.8 Job History (Detailed Counter) |
| 3.3 Rewriting of Firmware | 3.9 Counter/Data |
| 3.4 Trouble Shooting | 3.10 Others |
| 3.5 Machine Adjustments | 3.11 Appendix |
| 3.6 Process Adjustments | 3.12 Lesson Review |

NARRATION:

The following topics will be covered in this Lesson.

3.1 Maintenance

- ❖ [Maintenance Items](#) 
- ❖ [Replaced Parts List](#) 
- ❖ [Life Value](#) 

NARRATION:

The PDF links shown here provide additional information of the maintenance items, replacement parts and expected life values.

3.2 Service Tool (1/2)

❖ Main Differences

Items	C7000/C7000P/C6000/C8000	C6501/C6501P/C65hc	Details
New Jigs	Management Tool Loading wagon Trimmer unit support board	-	-
Job History Store to Location	HDD/P	HDD/K	HDD (option) is changed from 4ch (CMYK) to 6ch (CMYKAP). Data cannot be recovered if the Pch is broken.
Panel Log	New Addition	-	For troubleshooting
Management Tool	New Addition	-	Control the Counter information of the ORU-M Target Units.

[Service Material List](#) 

[Jig List](#) 

NARRATION:

In this table we see the Main Differences for the C7000 Service Tools.

For additional details, refer to the attached pdf files.

3.2 Service Tool (2/2)

❖ Panel Log

▪ Function

- Display the Operation History of the Main Body Touch Panel and the Control Panel Keys

▪ Purpose

- To check the operation by users when an abnormality occurs
- To analyze the problem and sending it to Support

▪ Items recorded:

Touch Panel Operation, Control Panel Key Operation

▪ Items not recorded:

Mouse Operation, External Keyboard Operation

▪ Maximum Storable Number: 1024 (deleted by power OFF)

▪ In Security Mode:

The Panel Log reference is unavailable as the Main Body NIC Network cannot be connected

Panel Log

Mon Jan 18 19:20:57 UTC

[Panel Log](#) 

No.	scroode	kind	detail	mean	time
170	0x1000	Pop	0x43bd26	---	19:17:35
169	0x1000	Push	0x422026	---	19:17:35
168	0x1000	Pop	0x43bd36	---	19:17:34
167	0x1000	Push	0x422236	---	19:17:34

NARRATION:

The Panel Log function allows the monitoring of the Touch Panel and the Control Panel Keys.

3.3 Rewriting of Firmware

❖ Main Differences

Items	C7000/C7000P/C6000/C8000	C6501/C6501P/C65hc	Details
Boot USB Memory ISW	New Addition	-	Removal of ISWTrns
Internet ISW	Web Utilities Version Operation Panel Version CS Remote Care Version	Web Utilities Version Operation Panel Version Mail Remote Notification System	Mail Remote Notification System is eliminated, CSRC Version was added
File Checksum	Conduct with ISWTrns_G	Conduct with ISWTrns	Use before rewriting the Firmware of Image Control (Collective IO)

NARRATION:

Shown in this table are the Main Differences for the Rewriting of Firmware for the C8000.

3.3 Rewriting of Firmware (2/3)

❖ Boot USB Memory ISW

▪ Function

- Rewrite the firmware of the Overall Control Board (OACB) when turning ON the power.

▪ Purpose

- Use when the program of the Overall Control Board (OACB) or the data for the display of the Operation Panel has an abnormality and does not start up.

* Alternative function of ISWTrns

[Boot USB Memory ISW](#)

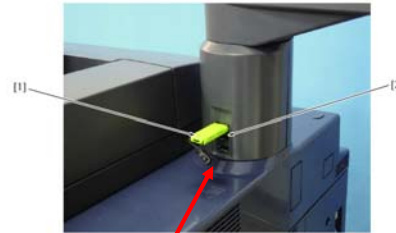

Service Port

NARRATION:

Boot USB Memory ISW allows the rewriting of the firmware of the Overall Control Board when turning On the power.

3.3 Rewriting of Firmware (3/3)

❖ File Checksum of ISWTrns_G

▪ Function

- Execute the checksum of firmware

▪ Purpose

- Use this function before rewriting the firmware of the Image Control (Collective (10)).

▪ Method

- Use ISWTrns_G.

[Sum File Check](#)

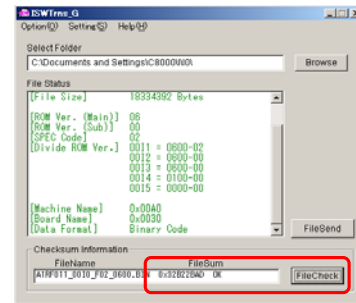

NARRATION:

Here is the method of checking the Checksum of the ISW Trans G Firmware.

3.4 Troubleshooting

❖ Main Differences

Items	C7000/C7000P/C6000/C8000	C6501/C6501P/C65hc	Details
Jam Codes	Jam Codes Changed/Added	-	Jam Codes Revised
Malfunction Codes	Malfunction Codes changed/added	-	Malfunction Codes Revised
Troubles that do not display a Malfunction Code	New Addition	-	New Addition
Malfunction Code caused by Connector Disconnection	New Addition	-	New Addition

NARRATION:

Here are the main differences of the changes for the C7000 Trouble Shooting.

3.5 Machine Adjustments

- Main Differences
- Skew Initial Position Memory
- Cross Direction Initial Position Memory
- Color Registration Manual
- Color Registration Automatic Adjustment

NARRATION:

In this section we will cover the Machine Adjustments

Main Differences

Items	C7000/C7000P/C6000/C8000	C6501/C6501P/C65hc	Details
Skew Initial Position Memory	New Addition	-	Conduct this adjustment when the Writing Unit is replaced
Cross Direction Initial Position Memory	New Addition	-	Do not conduct this adjustment in the field since it has been done on the Production Line.
Color Registration Manual	No need to perform the Mechanical Adjustment	Conduct the Mechanical "Mag (PART)" Adjustment when a NG Display remains.	Lens Adjustment Mechanism is added to the Writing Unit. "Mag (PART)" Adjustment is conducted in the Color Registration Automatic Adjustment. The Mechanical "Mag (PART)" adjustment of the C6501 has been discontinued.

NARRATION:

This table covers the Main Differences for the Machine Adjustments.

Skew Initial Position Memory

❖ Function

- Store the Initial Position of the Skew Adjustment Mechanism of the Writing Unit in the NVRAM Board (NRB).

❖ Purpose

- Conduct this adjustment when the Writing Unit is replaced.
- Use this function when the misalignment cannot be corrected by the Auto Color Registration Correction in the User Mode nor the Color Registration Auto. Adj. (Printer Adjustment).

NARRATION:

The Skew Initial Position Memory is used to store the Initial Position of the Skew Adjustment Mechanism of the Writing Units in the NVRAM Board.

Use this function when the misalignment cannot be corrected by the Auto Color Registration Correction, in the User Mode nor with the Color Registration Auto Adjustment, (Printer Adjustment).

Cross Direction Initial Position Memory

❖ Function

- Store the Initial Position of the Horizontal Magnification (Magnification in the Main Scan Direction) Adjustment Mechanism of the Writing Unit in the NVRAM Board (NRB).

NOTE:

Do not conduct this adjustment in the field since it has been done in the production line.

NARRATION:

The Cross Direction Initial Position Memory is used to store the Initial Position of the Skew Adjustment Mechanism of the Writing Units in the NVRAM Board. This adjustment has been performed in the factory and should not be performed in the field.

3.6 Process Adjustment

- Main Differences
- Color Registration Automatic Adjustment

NARRATION:

In this section we will cover the Process Adjustments.

Main Differences

Items	C7000/C7000P/C6000	C6501/C6501P/C65hc	Details
Beam Pitch Adjustment	New Addition	-	Conduct this adjustment when the Writing Unit is replaced
Moire Adjustment	New Addition	-	Conduct this adjustment when the Writing Unit is replaced
Drum Speed Adjustment (In Color Registration Automatic Adjustment)	When executing "Color Registration Auto Adjustment" from Service Mode, automatically adjust to the proper speed for the Intermediate Transfer Belt Speed.	None (Fixed because of non-volatile setting)	-

NARRATION:

Here are the Main Differences of the Machine Adjustment.

3.6 Beam Pitch Adjustment

❖ Function

- Adjust the Beam Pitches of LD1 to LD8 by the changing of the Writing Clock Signal.

❖ Purpose

- Conduct this adjustment when the Writing Unit is replaced.

NOTE

Be sure that the "Skew Initial Position Memory " and "Color Registration Auto.Adj." have been adjusted in advance.

Be sure to set the current value of the "Moire Adjustment (Printer Adjustment)" to 0 before conducting this adjustment.



[Beam Pitch Adjustment](#) 

NARRATION:

The Beam Pitch adjustment allows for the changing of the individual Beam Pitches of LD 1 thru LD 8. This adjustment should be performed when the Writing Unit has been replaced. Make sure that the Skew Initial Position and the Color Registration Automatic Adjustments have been adjusted prior to running the Beam Pitch Adjustment. Also, be sure to set the Current Value of the Moire Adjustment (Printer Adjustment) to Zero before conducting this adjustment.

3.6 Moire Adjustment

❖ Function

- Prevent moire by lowering the laser powers of LD1 and LD8 to absorb the changes of the beam pitch interval in the sub scan direction.

❖ Purpose

- Conduct this adjustment when the writing unit is replaced.

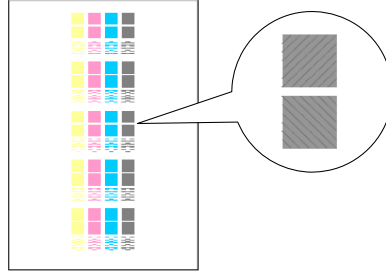

NOTE

Be sure that the "Skew Initial Position Memory", "Color Registration Auto.Adj." and "Beam Pitch Adjustment " have been adjusted in advance.

[Moire Adjustment](#)



NARRATION:

The Moire Adjustment prevents Moire Images by lowering the power of the lasers to absorb the changes in the Beam Pitch Interval in the Sub Scan Direction.

Make sure that the Skew Initial Position and the Color Registration Automatic Adjustments and the Beam Pitch Adjustment have been adjusted prior to running the Moire Adjustment.

3.6 Color Registration Automatic Adjustment (1/2)

❖ Differences

- When executing Color Registration Automatic Adjustment (Printer Adjustment) from Service Mode
Before Color Registration Automatic Adjustment starts, it automatically adjusts the Drum Speed to the Speed for the Vertical Magnification adjusted intermediate transfer belt.
→ Execute automatically and display the result on the screen
- Since the leading edge timing is influenced by drum speed automatic adjustment, execute the fine adjustment.

❖ Cause

- Since the drum speed is fixed in the C6501/C6501P/C65hc, the color registration variation gets worse because of the relative speed of the intermediate transfer belt and the drum out from the proper point when the intermediate transfer belt speed is changed by the vertical magnification adjustment.
- * However, the drum speed automatic adjustment is not executed for the color registration adjustment in the normal mode. (as ordinary)

NARRATION:

Here are the differences for the Color Registration Automatic Adjustment and the reasoning of why it was developed.

Color Registration Automatic Adjustment (2/2)

❖ Screen Display

Color Registration Auto. Adj. Screen

Displayed when Color Registration Automatic Adjustment completes

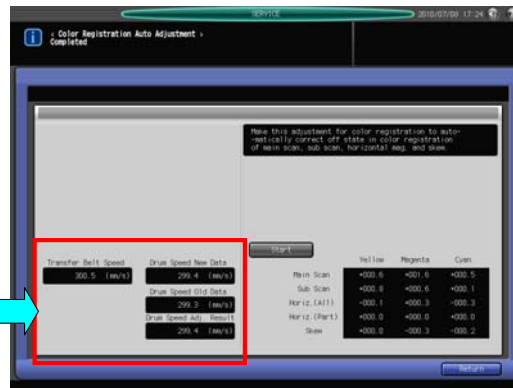

Intermediate Transfer Belt Speed: Shows current Non-Volatile Value Drum /K Speed
New Set Value: Set Value after adjustment (When the adjustment fails, the Non-Volatile is not updated and the Old Set Value is displayed)
Old Set Value: Non-volatile Value before adjustment
Result: Adjust value calculated from the Speed Adjustment

NARRATION:

The result of the adjustment of the black drum rotation speed to the intermediate transfer belt speed is displayed when the color registration automatic adjustment is completed.

The drum speed is the value of black drum and a New set value, old set value, and the adjustment results are displayed.

When the adjustment fails, the NG value is displayed as the result.

Since it cannot be used as new set value, the value which is the same as the old set value will be displayed.

3.7 Software DIPSW

▪ **Main Differences (1/4)**

- DIPSW 2-5/6 Adjustment Value Combination Ratio in the Density Balance Adjustment
- DIPSW24-1 Image stabilization control during idling
- DIPSW24-3 Image stabilization priority periodic adjustment
- DIPSW24-4/5 Developing preliminary rotation after long time idling
- DIPSW 26-0 Trigger Judgment of the Color Registration Automatic Correction
- DIPSW27-1/2 Band creation control for drum cleaning

▪ **Main Differences (2/4)**

- DIPSW1-1 Note display when fusing JAM occurs
- DIPSW5-0 For fusing unit per size
- DIPSW 20-5 Curl Adjustment Setting after Auto Reset
- DIPSW27-3 Fusing separation fan abnormality detection

▪ **Main Differences (3/4)**

- DIPSW 8-7 Custom Size Counter Threshold Setting
- DIPSW 12-0 Counter per Mode (2)
- DIPSW 33-0/1/2/3 TC Counting Method
- DIPSW 33-7 Charge Count Setting

▪ **Main Differences (4/4)**

- DIPSW 15-0 ORU-M Operator Release Setting
- DIPSW 16-7 ORU-M Developing Unit Counter Setting
- DIPSW 23-1 Operation when storing the Maximum Hold Jobs
- DIPSW 40-1 Overwrite All HDD Data

NARRATION:

Here is list of the differences covering the software dip switches.

Main Differences (1/4)

❖ DIPSW related to the Image Stabilization/Process

Items	C7000/C7000P/C6000	C6501/C6501P/C65hc	Details
DIPSW 2-5/6 Adjustment Value Combination Ratio in the Density Balance Adjustment	New Addition	-	New Addition
DIPSW 24-1 Image Stabilization Control During Idling	New addition	-	New addition
DIPSW 24-3 Image Stabilization Priority Periodic Adjustment	New addition	-	New addition
DIPSW 24-4/5 Fusing Preparatory Rotation after a Long Time Idling	New addition	-	New addition
DIPSW 26-0 Trigger Judgment of the Color Registration Automatic Correction	New Addition	-	New Addition
DIPSW 27-1/2 Band Creation Control for Drum Cleaning	New addition	-	New addition

NARRATION:

This table covers the Main Differences for the DIP Switch Settings that are related to the Image Stabilization Control.

DIPSW2-5/6 Adjustment Value Combination Ratio in the Density Balance Adjustment

❖ Function

- Set the combination (merging) ratio of adjustment value when registering the profile that has been registered on "Machine Screen" – [Adjustment] - "Density Balance Adjustment."
- The color /gradation may change drastically because of the engine process element. Use this setting to change the ratio for merging the profile.

NOTE:

Merging the profile is available between the data whose conditions; "Screen", "Paper Type", and "Weight" are matched.

Mode	2-6	2-5
5:5 = new:old adjustment value	0	0
7:3 = new:old adjustment value	0	1
3:7 = new:old adjustment value	1	0
6:4 = new:old adjustment value	1	1

NARRATION:

The Dip Switch 2 5 and 6 Adjustment allows the setting of the merging ratio of the Density Balance Adjustment between new and old adjustment values. This is performed when the engine process color gradation changes drastically.

DIPSW 24-1 Image Stabilization Control during Idling

❖ Function

- **Change the execution timing of the Image Stabilization Control during idling and shorten the waiting time before the printing starts**

Mode	24-1
Disabled: Even if the environmental humidity during idling reaches the specified level, the Image Stabilization Control is executed after idling completes and before starting the next job	0
Enabled: When the environmental humidity during idling reaches the specified level, the Image Stabilization Control is executed even during idling	1

NOTE

- **When this setting is enabled (1), the lives of the Developer and Drum are shortened since the number times the Image Stabilization Control is executed increases under environments with large humidity ranges.**
- **When setting it to 1, there might be a case in which the Image Stabilization does not execute before starting job since the time before the next job starts is long.**

NARRATION:

For DIP SWITCH 24-1, Image stabilization control during idling, the waiting time before printing starts can be shortened by changing the execution timing.

When this setting is disabled (0), even if the environmental humidity during idling reaches the specified level, the image stabilization control waits until the idling completes and executes before starting next job.

When setting it to enabled (1) and the environmental humidity during idling reaches the specified level, the image stabilization control executes even during idling. With this operation, the waiting time for starting print can be shortened.

But note that when this setting is enabled (1), the lives of the developer and drum are shortened since the number of times the image stabilization control is run increases.

DIPSW 24-3 Image Stabilization Priority Periodic Adjustment

❖ Function

- Even when "Stability" is set in "Quality Adjustment" of "Utility", the Image Stabilization Control for the job suspended period during continuous printing is set to disabled

❖ Usage

- When "Stability" is set in "Quality Adjustment" of "Utility", and the Color and Image Density are changed greatly before and after the Image Stabilization Control between jobs, change the setting to disabled (1).

Mode	24-3
Enabled: When "Quality Adjustment" in Utility is set to "Stability", the image stabilization control execute	0
Disabled: Even when "Quality Adjustment" in Utility is set to "Stability", the image stabilization control between jobs during continuous printing is set to disabled and will not execute	1

NARRATION:

With DIP SWITCH 24-3 Image Stabilization Priority Periodic Adjustment, when [Stability] is selected from "Utility" – "Quality Adjustment", [04 Stabilization Adj. Setting], the color and image density are change greatly before and after the image stabilization control between jobs.

When the DIP SWITCH 24-3 is set to disabled (1), the image stabilization control for the job suspended period during continuous printing will not execute even when [Stability] is selected.

DIPSW 24-4/5 Developing Preliminary Rotation after Long Time Idling

❖ Function

- Set the Developing Preliminary Rotation Pattern after a Long Time Idling

❖ Usage

- Set this setting to enabled when the Image Density is not stable after a Long Time Idling

Mode	24-5	24-4
Not executed	0	0
Every 1 hour during idling	0	1
At starting printing after idling for more than 1 hour	1	0
Disable	1	1

NARRATION:

When using DIP SWITCH 24-4 & 5, the developing preliminary Rotation after Long Time Idling, it is recommended that of you set one of three developing preliminary rotation patterns after long time idling. Use this setting when the image density is not stable after a long time idling.

DIPSW 26-0 Trigger Judgment of the Color Registration Automatic Correction

❖ Function

- Set the standard to judge the timing for the execution of the Color Registration Correction.

NOTE:

Do not set this setting to "1" normally, since setting to "1" will use the same control as the C6501.

Mode	26-0
Process Unit Temperature (Execute the Color Registration Correction when the Process Mount Temperature changes more than the specified level from the previous correction.)	0
Number of Prints (Execute the Color Registration Correction after printing a specified amount of pages from the previous correction.)	1

NARRATION:

DIP Switch 26-0 will set the timing of when to execute the Color Registration Correction. The correction timing has been changed for the C7000 and is now executed by the determination of the Process Unit Temperature. If this is changed to a "1", then it would revert to the method used by the C6501, which is based on the number of prints.

DIPSW 27-1/2 Band Creation Control for Drum Cleaning

❖ Function

- Set the implementation way of creating the Toner Band on the specified paper interval. (In High Temperature Environments, the lines in the Sub Scan Direction is most likely to occur. The Toner Band is used to effectively prevent this problem.)

❖ Usage

- When the lines in the Sub Scan Direction occur on the Half Tone Image in other than the High Temperature Environments → Set to " Create under any environment "
- When giving priority to the productivity regardless of Image Quality.
→Set to " Not Create "

Mode	27-2	27-1
Create under the High Temperature Environments	0	0
Create under the High, and Ordinary Temperature Environments	0	1
Create under any Environment	1	0
Not Create	1	1

NARRATION:

The DIP SWITCH 27-1/2 is used for the Band Creation Control for Drum Cleaning, in high temperature environments, the lines in the sub scan direction are likely to occur. By creating toner belt is effective to prevent this problem.

When the lines in the sub scan direction occurs in other than the high temperature environment, it can be improved by setting to "Create under any environment".

Also, when giving priority to the productivity regardless of image quality, set to "Not create".

Main Differences (2/4)

❖ DIPSW related to Fusing

Items	C7000/C7000P/C6000	C8000	Detail
DIPSW1-1 Note display when Fusing Jam occurs	New addition	-	New addition
DIPSW5-0 For Fusing Unit per Size	New addition	-	New addition
DIPSW 20-5 Curl Adjustment Setting after Auto Reset	New Addition	-	New Addition
DIPSW27-3 Fusing Separation Fan Abnormality Detection	New addition	-	New addition

NARRATION:

Here are the Main Differences of the DIP SWITCHES related to fusing.

DIPSW 1-1 Note Display when Fusing Jam Occurs

❖ Function

- Display the steps to clear Fusing Jams

Mode	1-1
Disabled	0
Enabled	1

[Paper Setting] ⇒ [Change Setting]



Change Individual Setting Screen

Screen Display when Fusing Jam occurs



***Turn on DIPSW 1-0 (Process Adjustment User Screen Display)**

NARRATION:

DIP SWITCH 1-1 enables a Note to be displayed when a fusing Jam occurs.

When set to enabled (1), the [Note] button will be displayed on the "Change Individual Setting Screen".

The "Screen display when a fusing JAM occurs" can be displayed from the [Note] button to provide users steps on handling the paper or other steps that can reduce or eliminate future paper jams.

DIPSW 5-0 For Fusing Unit per Size

❖ Function/Usage

- When using the Fusing Unit A/B per size, identify the Fusing Unit currently used and display the identification on the screen. Use this when there is trouble with the Fusing Edge Lines.
- Identify by Short Connector existing/not existing
Display “Fusing (Small Size)”: Connector not existing
 “Fusing (Large Size)”: Connector existing
- Can be counted per Fusing Unit



Mode	5-0
Disabled	0
Enabled	1

Fusing Edge Lines 

NOTE: When this setting is enabled (1), the ORU-M Function cannot be used

When using two fusing units A/B for size prevention troubles, such as scratches on the paper, the fusing unit identification can be displayed on the lower right side of the screen by this function.

This identification is carried out by whether the short connector of the fusing unit exists or not.

“Fusing (small size)” display refers that the connector is not connected and “Fusing (large size)” display refers that the connector is connected.

This can be checked by input check “59-0” of I/O.

It can be counted per fusing unit.

The condition in which the fusing edge lines are likely to occur is

When printing the long-sized paper (A3 or 11x17, for example) in the main scan direction after printing more than 1000 short-sized thick paper (A4S Letter P, for example) in the main scan direction.

When using this function, the ORU-M Function cannot be used at the same time because this function requires two units of non-volatile counter memory area (for large size/ small size) and the

ORU-M function also uses the same two units. Since these two functions cannot coexist, you have to choose which one your customer needs.

При использовании двух блоков термозакрепления А / В для предотвращения проблем с размером, таких как царапины на бумаге, эта функция может отображать идентификацию блока термозакрепления в нижней правой части экрана.

Эта идентификация выполняется в зависимости от того, существует ли короткий разъем блока термозакрепления или нет.

Дисплей «Fusing (малого размера)» означает, что разъем не подключен, а дисплей «Fusing (большого размера)» означает, что разъем подключен.

Это можно проверить с помощью проверки входа «59-0» ввода / вывода.

Это может быть посчитано за единицу слияния.

Условие, при котором линии плавления кромок могут возникать,

При печати на бумаге большого формата (например, А3 или 11x17) в направлении основного сканирования после печати более 1000 толстых листов короткого формата (например, А4S Letter P) в направлении основного сканирования.

При использовании этой функции нельзя одновременно использовать функцию ORU-M, поскольку для этой функции требуется две единицы области памяти энергонезависимого счетчика (для большого размера / малого размера) и Функция ORU-M также использует те же две единицы. Поскольку эти две функции не могут сосуществовать, вы должны выбрать ту, которая нужна вашему клиенту.

DIPSW 20-5 Curl Adjustment Setting after Auto Reset

❖ Function

- Set whether to reset the value of the "Paper Setting" - "Curl Adjustment" to 0 and the Humidifier Setting to default or not at Auto Reset.

NOTE:

The default (ON/OFF) of the Humidifier Setting differs depending on the Paper Type and Weight.

Mode	20-5
Not Reset	0
Reset	1

NARRATION:

DIP Switch 20-5 will set whether to reset the Paper Setting, Curl Adjustment to "0" and the Humidifier Setting to default when a Auto Reset is performed.

DIPSW 27-3 Fusing Separation Fan Abnormality Detection

❖ Function

- When any abnormality of the Fusing Separation Fans /1 (FM7), /2 (FM8) and /3 (FM9) occurs, enables the Main Body temporarily by disabling the Error Detection and isolating the faulty part (fan)

Mode	27-3
Error Detection Enabled	0
Error Detection Disabled (Isolate the faulty part of the fan error)	1

NOTE:

However, jams in the Fusing Section may occur when using Coated Thin Paper because the printing starts without rotating the Fusing Separation Fans.

NARRATION:

When any abnormality of the fusing separation fans /1 (FM7), /2 (FM8) and /3 (FM9) occurs, this function enables the main body to temporarily disable the error detection and isolating the faulty fan.

When setting it to enabled (0), normal error detection will be conducted. When setting it to disabled (1), it isolates the error fan and temporarily enables the main body.

Main Differences (3/4)

❖ DIPSW Settings related to the Counters

Items	C7000/C7000P/C6000/C8000	C6501/C6501P/C65hc	Details
DIPSW 8-7 Custom Size Counter Threshold Setting	New Addition	-	New Addition
DIPSW 12-0 Counter per Mode (2)	New Addition	-	New Addition
DIPSW 33-0/1/2/3 TC Counting Method	New Addition	-	New Addition
DIPSW 33-7 Charge Count Setting	New Addition	-	New Addition

NARRATION:

This table covers the Main Differences for the DIP Switch Settings that are related to the Counters.

DIPSW8-7 Custom size counter threshold setting

❖ Function

- Setting this DIPSW to “1” displays the “Custom Size Threshold Setting screen.”
- 4 types of custom size threshold can be changed.
- Setting range: 0 to 487
- 1step = 1mm

Mode	8-7
Not display	0
Display	1



NARRATION:

This Dip Switch is used to program how custom paper sizes are counted.

DIPSW 12-0 Counter per Mode (2)

❖ Function

- Counter per Mode (2) No.1 to 9 Display/Not Display the Counts per Color Mode Setting

Mode	12-0
No.1 to 9 Not Display the Counts per Color Mode	0
No.1 to 9 Display the Counts per Color Mode	1

NARRATION:

DIP Switch 12-0 will set whether or not to display the Counts per Color Mode.

DIPSW33-0/1/2/3 TC counting method

❖ Function

- DIPSW33-2/3: Set the threshold of the double count size in the sub scan direction.

Mode	33-3	33-2
330mm or more in the sub scan direction	0	0
355mm or more in the sub scan direction (except for the U.S)	0	1
420mm or more in the sub scan direction (the U.S)	1	0
All size is counted as small size	1	1

- DIPSW33-0/1: Set the count number to the double count size paper which is set with DIPSW33-2/3.

Mode	Japan	U.S	Europe
DIPSW33-0 TC black and white large size count method	0 (1 count)	1 (2 count)	0 (1 count)
DIPSW33-1 TC color large size count method	0 (1 counts)	1 (2 counts)	0 (1 counts)

DIPSW33-7 Charge count setting

❖ Function

- Setting this DIPSW to 1 changes the “Total counter” on the “Utility screen” to the “Billing Total Counter.”



- To display this screen, set DIPSW33-7=1.
- The value cannot be acquired from the Web Utilities unless setting 33-7=1. (Coefficient is not reflected.)
- Items of the billing counter cannot be printed on the list output unless setting 33-7=1.

Mode	33-7
Disabled	0
Enabled (Displays "Billing Total Counter")	1

Main Differences (4/4)

❖ DIPSW Settings related to the ORU-M/Others

Items	C7000/C7000P/C6000/C8000	C6501/C6501P/C65hc	Details
DIPSW 15-0 ORU-M Operator Release Setting	New Addition	-	New Addition
DIPSW 16-7 ORU-M Developing Unit Counter Setting	New Addition	-	New Addition
DIPSW 23-1 Operation when Storing the Maximum Number of Hold Jobs	New Addition	-	New Addition
DIPSW 40-1 Overwrite all HDD Data	New Addition	-	Same as the 1200

NARRATION:

This table covers the Main Differences for the DIP Switch Settings that are related to the ORU-M and miscellaneous others.

DIPSW15-0 ORU-M Operator Release Setting

❖ Function

- Setting to release the ORU-M (Operator Replaceable Unit Management) to the operator

NOTE:

When changing this setting to 1, be sure the operator is trained and a certificate has been issued before setting this to a 1.

Mode	15-0
ORU-M unavailable	0
ORU-M available	1

NARRATION:

Dip Switch 15-0 sets whether or not to enable the ORU-M Function. The Operator must be trained and certified prior to this being set to a 1.

DIPSW16-7 ORU-M Developing Unit Counter Setting

❖ Function

- User can enter the Life Counter (distance and quantity) of the Developing Units.

❖ Purpose

- Set this function when 3 or more developing units are used for 1 color.

Mode	16-7
Disabled	0
Enabled	1

NOTE:

When using this function, the customer needs to manage the Counters of the Developing Unit.

NARRATION:

With Dip Switch 16-7 the Customer can enter the Life Counters of the Developing Units.

DIPSW 23-1 Operation when Storing the Maximum Number of Hold Jobs

❖ Function

- A maximum of 100 Hold Jobs can be stored. This function sets the operation that will be done when 100 Jobs have been stored.

Mode	23-1
Not Delete Automatically (Restrict to receive any new Copier/Printer Hold Jobs)	0
Delete the Oldest Hold Job and receive a New Job	1

NARRATION:

DIP Switch 23-1 will determine if any new jobs will be allowed when the maximum number of 100 Hold Jobs is reached or to delete the Oldest Job.

DIPSW40-1 Overwrite all HDD Data

❖ Function

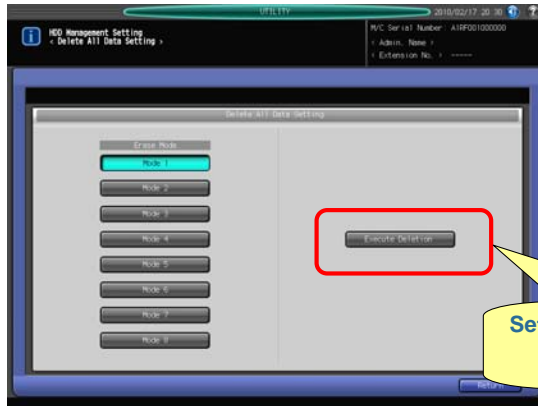

Caution

Mode	40-1
Restrict	0
Allow	1

Setting 40-1 = 1 enables the "Deletion Execute" Key.

NOTE

- Setting this mode to " 1 " and executing the following step will disable the machine. Therefore, do not execute the steps except when throwing the machine away. "Utility menu" - "03 Administrator Setting" - "10 Security Setting" - "02 HDD Management Setting" - "03 Delete All Data" - "Deletion Execute" on "Mode 1" to "Mode 8."

NARRATION:

Do Not use Dip Switch 40-1, the Overwrite all Hard Disk Data Function, as it will disable the machine. It should only be used when the machine is being replaced and sent to another location or back to a leasing company.

3.8 Job History (Detailed Counter)

❖ Applicable Models

bizhub PRESS C8000

bizhub PRESS C7000/C6000/C7000P

NARRATION:

Here is the Job history or detailed counter for the following applicable models.

3.8 Job History (Detailed Counter)

❖ System Configuration

Outline

When accessing Main Body Web, counter_sample.html page is retrieved first. Then, JavaScript files of external Web Server are retrieved. Lastly, Detail Count Data is retrieved via Main Body Web. When all the data is ready, the browser renders the data to the table.

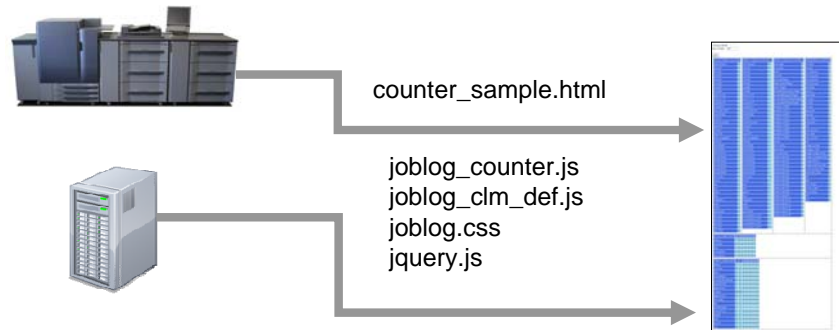

NARRATION:

HTML is used to show the Job history (detailed counter) and is dynamically created by JavaScript.

However, main body NIC cannot process the Java Script and an external web server that is capable to process the JavaScript is necessary.

3.8 Job History (Detailed Counter)

❖ Column Mode Specification

A command to change a Column Mode

Address  http://10.11.32.36/goform/joblog.cgi?viw=A

Input the following commands to this part of the address bar, right after "?".

http://X.X.X/goform/joblog.cgi?viw=A

Variable Name	Signification	Value
clmmode	Specify the column mode	0 : Normal Mode 1 : Detailed Mode Ex. clmmode=1 acquire the data with a Detailed Mode.

NARRATION:

A command to change the column mode was added.

3.8 Job History (Detailed Counter)

❖ Setup Procedure

Items to be prepared

- Windows PC which provides Web Service
In this set up procedure, Windows XP Professional is used.

- File for Job History (Detailed Counter) (5 files)
 - Template File (installed to Main Body)
counter_sample.html

 - Library File (installed to External Web Server)
joblog_counter.js
joblog_clm_def.js
joblog.css
jquery.js

NARRATION:

You need to prepare these items before starting the setup of Job history (detailed counter).

3.8 Job History (Detailed Counter)

❖ Setup Procedure

Step 1:

Open Control Panel and click on “Add or Remove Programs”

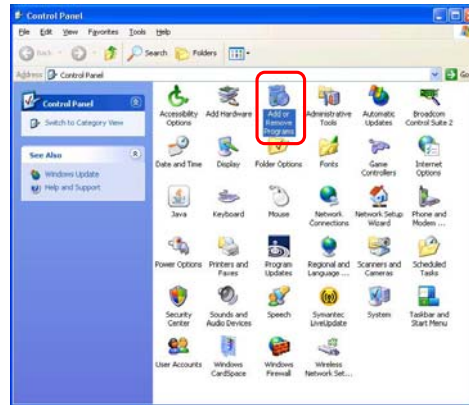

NARRATION:

Install IIS on the PC to install the Web server. Open the control panel and click on “Add or Remove Programs”.

3.8 Job History (Detailed Counter)

❖ Setup Procedure

Step 2:

Click “Add/Remove Windows Components”.

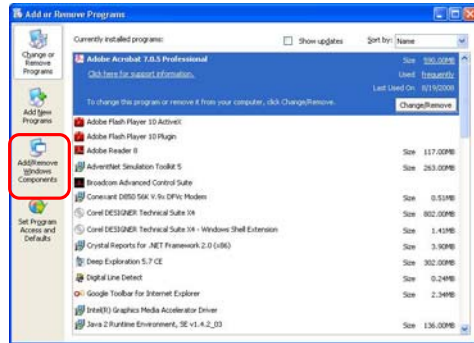

NARRATION:

Click “Add/Remove Windows Components”.

3.8 Job History (Detailed Counter)

❖ Setup Procedure

Step 3:

Select “Internet Information Services (IIS)” then click “Next” button. The installation starts. Load Windows install CD-ROM as needed.

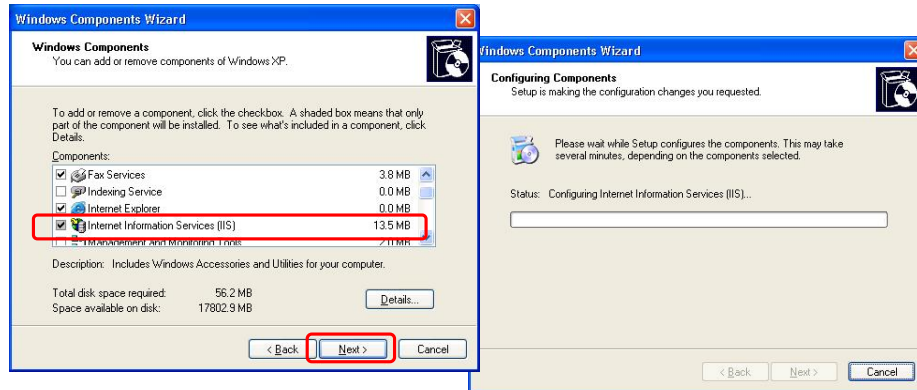

NARRATION:

To install IIS, Windows install CD-ROM may be required.

3.8 Job History (Detailed Counter)

❖ Setup Procedure

Step 4:

When the installation completes, following screen appears.
Click "Finish"



NARRATION:

When the installation completes, following screen appears. Click "Finish."

3.8 Job History (Detailed Counter)

❖ Setup Procedure

Step 5:

Startup the Text Editor and open "Counter_sample.html".
Edit the yellow highlighted part of following.

```
<script type="text/javascript"  
src="http://10.9.0.20/~kita/Ajax/100222joblog/joblog_counter.js"></script>
```

Enter the URL where "joblog_counter.js" can refer on the Web server.
Here, overwritten with http://10.11.2.143/joblog_counter.js

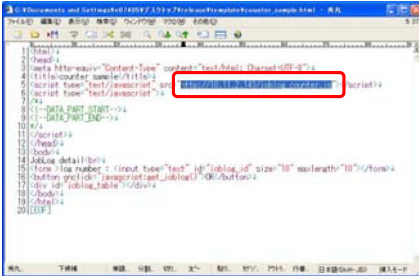

```
1 <html>  
2 <head>  
3 <meta http-equiv="Content-Type" content="text/html; charset=UTF-8">  
4 <title>counter sample</title>  
5 <script type="text/javascript" src="http://10.9.0.20/~kita/Ajax/100222joblog/joblog_counter.js"></script>  
6 </script type="text/javascript">  
7 />  
8 <!-- DATA_PAGID_START -->  
9 <!-- DATA_PAGID_END -->  
10 />  
11 /script>  
12 /head>  
13 /html>  
14 <div id="detail">  
15 <table border="1" style="width: 100%; border-collapse: collapse;">  
16 <tr>  
17 <td style="width: 50%; text-align: center;">  
18 <input type="text" value="10" style="width: 80%; height: 20px;" />  
19 <input type="button" value="OK" />  
20 </td>  
21 </tr>  
22 </table>  
23 </div>  
24 </body>  
25 </html>
```

NARRATION:

Edit the template and library files to be used to indicate the detailed counter, then install the files to the main body and the web server.

Please download Template and library files from CSES.

3.8 Job History (Detailed Counter)

❖ Setup Procedure

Step 6:

Open "Joblog_counter.js" file by Text Editor, then edit following yellow highlighted part.

var base_url = "http://10.9.0.20/~kita/Ajax/100222joblog/";

Enter the Web server path where "joblog_counter.js" is located.

Here, overwritten with <http://10.11.2.143/> ("/" must be attached at the last digit.)

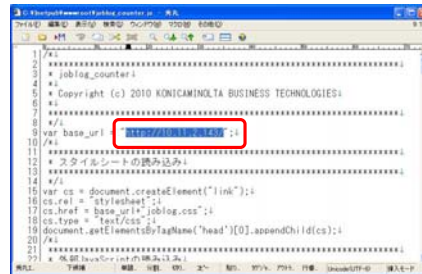

```
1 /x/
2
3 * joblog_counter.js
4 *
5 * Copyright (c) 2010 KONICAMINOLTA BUSINESS TECHNOLOGIES
6 *
7
8 *
9 var base_url = "http://10.11.2.143/";
10
11
12 * 2分以内のジョブの読み込み
13
14 *
15
16 var cs = document.createElement("link");
17 cs.rel = "stylesheet";
18 cs.href = base_url + "joblog.css";
19 document.getElementsByTagName("head")[0].appendChild(cs);
20
21
22 *
23 * 本誌は、本誌の著作権を、本誌の著作権者に帰属します。
24
```

NARRATION:

Open the Job log counter file using a text editor and update the Web Server Path.

3.8 Job History (Detailed Counter)

❖ Setup Procedure

Step 7:

Access the Main Body NIC using Web Utilities. Click “Extension for Maintenance”.

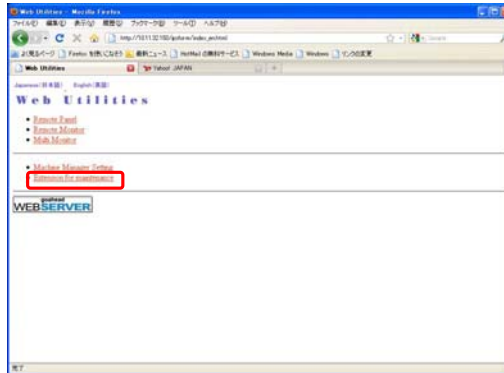

NARRATION:

Access the Main Body NIC by using the Web Utilities. Click, Extension for Maintenance.

3.8 Job History (Detailed Counter)

❖ Setup Procedure

Step 8:

Let the Main Body access to Service Mode.

Then, click "Machine Setting Data Import" on the Web Page of Main Body.

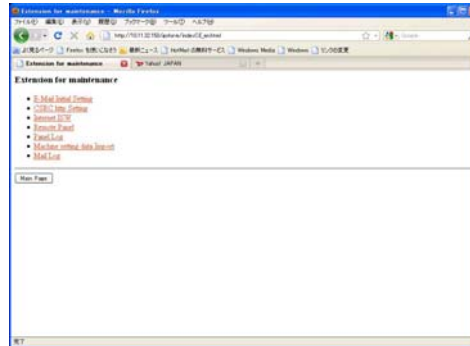

NARRATION:

Let the Main Body access the Service Mode. Then, Click, Machine Setting Data Import on the Main Body Web Page.

3.8 Job History (Detailed Counter)

❖ Setup Procedure

Step 9:

At “Web Setting” line, click one of (A to J). Here, A is clicked.

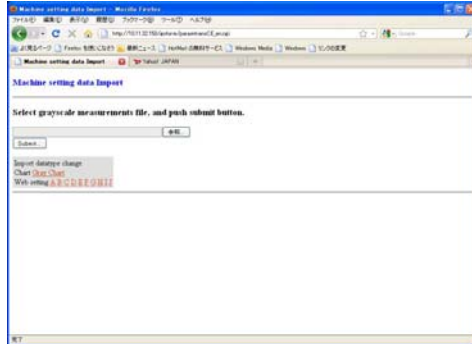

NARRATION:

On the Web Setting Line, Click one counter from A to J. Shown here, A is selected.

3.8 Job History (Detailed Counter)

❖ Setup Procedure

Step 10:

Click the Browse Button. Specify a file "Counter_sample.html" then click "Submit" Button. Now, "Counter_sample.html" is installed to Main Body.

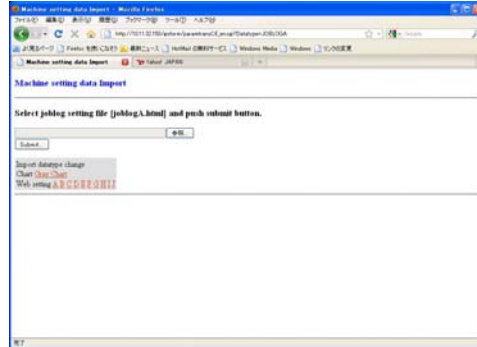

NARRATION:

Click the Browse Button. Specify the file, Counter_sample.html, then click, the Submit Button. The Counter_sample.html will now be installed to the Main Body.

3.8 Job History (Detailed Counter)

❖ Setup Procedure

Step 12:

If the following screen is indicated,
Click the “Advanced” Button.

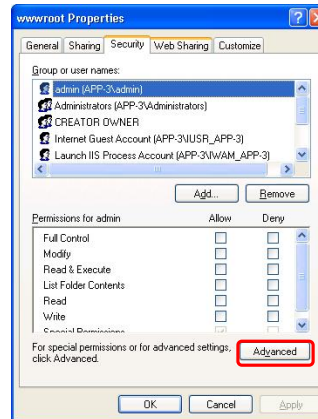

NARRATION:

If the Following Screen is indicated, Click the Advanced Button.

3.8 Job History (Detailed Counter)

❖ Setup Procedure

Step 13:

Check the Radio Button for “Replace permission entries on all child objects with entries shown here that apply to child objects”.

Then press “OK”. (This sets the access right for the Copied Library.)

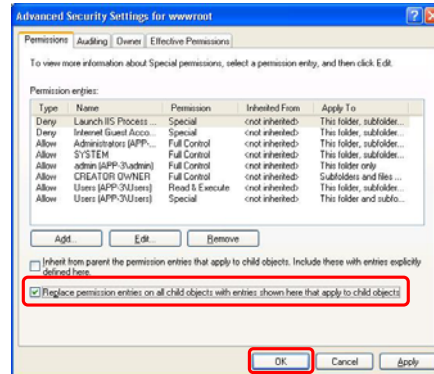

NARRATION:

Check the Radio Button for “Replace permission entries on all child objects with entries shown here that apply to child objects”.

Then press “OK”. (This sets the access right for the Copied Library.)

3.8 Job History (Detailed Counter)

❖ Setup Procedure

Step 14:

Access Web of Main Body NIC, then select "Machine Manager Setting" → "Job Log Details", following screen appears. Enter arbitrary number.

Detail Log can be viewed only from Firefox with current version.

IE is not currently supported.

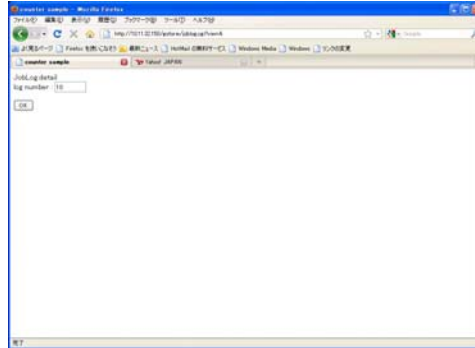

NARRATION:

Check if the detailed counter is accessible. The Detail Log can only be viewed using Firefox with the current version, IE is not currently supported.

3.8 Job History (Detailed Counter)

❖ Setup Procedure

Step 15:

When following display appears, the installation has completed successfully.

Refer to the following linked file
that is Detailed Counter
Specifications.

[JobLogCounterSpec](#) 

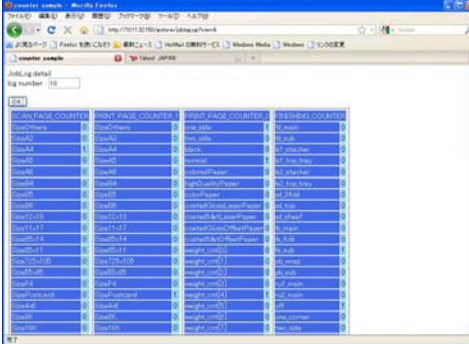

MAIN PAGE COUNTER	FRONT PAGE COUNTER	REPLY PAGE COUNTER	DETAILS COUNTER
Doc0000	Doc0000	Doc0000	Doc0000
Doc0001	Doc0001	Doc0001	Doc0001
Doc0002	Doc0002	Doc0002	Doc0002
Doc0003	Doc0003	Doc0003	Doc0003
Doc0004	Doc0004	Doc0004	Doc0004
Doc0005	Doc0005	Doc0005	Doc0005
Doc0006	Doc0006	Doc0006	Doc0006
Doc0007	Doc0007	Doc0007	Doc0007
Doc0008	Doc0008	Doc0008	Doc0008
Doc0009	Doc0009	Doc0009	Doc0009
Doc0010	Doc0010	Doc0010	Doc0010
Doc0011	Doc0011	Doc0011	Doc0011
Doc0012	Doc0012	Doc0012	Doc0012
Doc0013	Doc0013	Doc0013	Doc0013
Doc0014	Doc0014	Doc0014	Doc0014
Doc0015	Doc0015	Doc0015	Doc0015
Doc0016	Doc0016	Doc0016	Doc0016
Doc0017	Doc0017	Doc0017	Doc0017
Doc0018	Doc0018	Doc0018	Doc0018
Doc0019	Doc0019	Doc0019	Doc0019
Doc0020	Doc0020	Doc0020	Doc0020
Doc0021	Doc0021	Doc0021	Doc0021
Doc0022	Doc0022	Doc0022	Doc0022
Doc0023	Doc0023	Doc0023	Doc0023
Doc0024	Doc0024	Doc0024	Doc0024
Doc0025	Doc0025	Doc0025	Doc0025
Doc0026	Doc0026	Doc0026	Doc0026
Doc0027	Doc0027	Doc0027	Doc0027
Doc0028	Doc0028	Doc0028	Doc0028
Doc0029	Doc0029	Doc0029	Doc0029
Doc0030	Doc0030	Doc0030	Doc0030
Doc0031	Doc0031	Doc0031	Doc0031
Doc0032	Doc0032	Doc0032	Doc0032
Doc0033	Doc0033	Doc0033	Doc0033
Doc0034	Doc0034	Doc0034	Doc0034
Doc0035	Doc0035	Doc0035	Doc0035
Doc0036	Doc0036	Doc0036	Doc0036
Doc0037	Doc0037	Doc0037	Doc0037
Doc0038	Doc0038	Doc0038	Doc0038
Doc0039	Doc0039	Doc0039	Doc0039
Doc0040	Doc0040	Doc0040	Doc0040
Doc0041	Doc0041	Doc0041	Doc0041
Doc0042	Doc0042	Doc0042	Doc0042
Doc0043	Doc0043	Doc0043	Doc0043
Doc0044	Doc0044	Doc0044	Doc0044
Doc0045	Doc0045	Doc0045	Doc0045
Doc0046	Doc0046	Doc0046	Doc0046
Doc0047	Doc0047	Doc0047	Doc0047
Doc0048	Doc0048	Doc0048	Doc0048
Doc0049	Doc0049	Doc0049	Doc0049
Doc0050	Doc0050	Doc0050	Doc0050
Doc0051	Doc0051	Doc0051	Doc0051
Doc0052	Doc0052	Doc0052	Doc0052
Doc0053	Doc0053	Doc0053	Doc0053
Doc0054	Doc0054	Doc0054	Doc0054
Doc0055	Doc0055	Doc0055	Doc0055
Doc0056	Doc0056	Doc0056	Doc0056
Doc0057	Doc0057	Doc0057	Doc0057
Doc0058	Doc0058	Doc0058	Doc0058
Doc0059	Doc0059	Doc0059	Doc0059
Doc0060	Doc0060	Doc0060	Doc0060
Doc0061	Doc0061	Doc0061	Doc0061
Doc0062	Doc0062	Doc0062	Doc0062
Doc0063	Doc0063	Doc0063	Doc0063
Doc0064	Doc0064	Doc0064	Doc0064
Doc0065	Doc0065	Doc0065	Doc0065
Doc0066	Doc0066	Doc0066	Doc0066
Doc0067	Doc0067	Doc0067	Doc0067
Doc0068	Doc0068	Doc0068	Doc0068
Doc0069	Doc0069	Doc0069	Doc0069
Doc0070	Doc0070	Doc0070	Doc0070
Doc0071	Doc0071	Doc0071	Doc0071
Doc0072	Doc0072	Doc0072	Doc0072
Doc0073	Doc0073	Doc0073	Doc0073
Doc0074	Doc0074	Doc0074	Doc0074
Doc0075	Doc0075	Doc0075	Doc0075
Doc0076	Doc0076	Doc0076	Doc0076
Doc0077	Doc0077	Doc0077	Doc0077
Doc0078	Doc0078	Doc0078	Doc0078
Doc0079	Doc0079	Doc0079	Doc0079
Doc0080	Doc0080	Doc0080	Doc0080
Doc0081	Doc0081	Doc0081	Doc0081
Doc0082	Doc0082	Doc0082	Doc0082
Doc0083	Doc0083	Doc0083	Doc0083
Doc0084	Doc0084	Doc0084	Doc0084
Doc0085	Doc0085	Doc0085	Doc0085
Doc0086	Doc0086	Doc0086	Doc0086
Doc0087	Doc0087	Doc0087	Doc0087
Doc0088	Doc0088	Doc0088	Doc0088
Doc0089	Doc0089	Doc0089	Doc0089
Doc0090	Doc0090	Doc0090	Doc0090
Doc0091	Doc0091	Doc0091	Doc0091
Doc0092	Doc0092	Doc0092	Doc0092
Doc0093	Doc0093	Doc0093	Doc0093
Doc0094	Doc0094	Doc0094	Doc0094
Doc0095	Doc0095	Doc0095	Doc0095
Doc0096	Doc0096	Doc0096	Doc0096
Doc0097	Doc0097	Doc0097	Doc0097
Doc0098	Doc0098	Doc0098	Doc0098
Doc0099	Doc0099	Doc0099	Doc0099
Doc0100	Doc0100	Doc0100	Doc0100

NARRATION:
When the following display appears, the installation has completed successfully.

3.9 Counter/Data

- Main Differences
- Maintenance Counter Reset
- Parts History in Time Series
- ORU-M Maintenance History
- Custom Counter Threshold Set
- Maintenance Counter and Total Counter

NARRATION:

The following topics will be covered in this Section.

Main Differences

❖ Main Differences

Items	C7000/C7000P/C6000	C6501/C6501P/C65hc	Details
Maintenance Counter Reset	New Addition	-	Display the latest 10 items of the Maintenance Counter Reset History
Parts History in Time Series	New Addition	-	Display the latest 50 items of the Maintenance Counter Reset History
ORU-M Maintenance History	New Addition	-	Enabled when DIPSW15-0=1 Check the frequency of unit replacement
Custom Size Counter Threshold Setting	New Addition	-	Enabled when DIPSW8-7=1 Set the custom size paper length threshold in the Sub Scan Direction for "Paper Size Counter"

NARRATION:

This table covers the Main Differences for the Counters.

Maintenance Counter Reset

❖ Function

- Display the latest 10 items of the Maintenance Counter Reset History

❖ Purpose

- Check the frequency of the maintenance

❖ Item

- Reset Date
- Maintenance Counter
- Maintenance Limit Data
- Counter Average
- Counter Reset Count

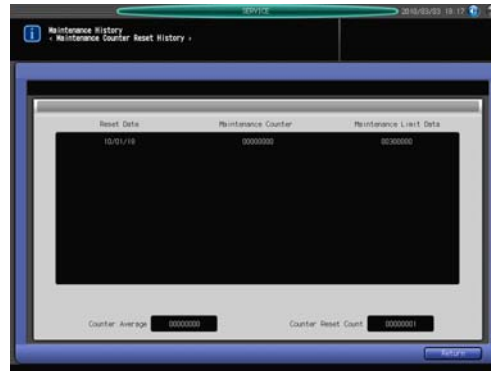

NARRATION:

The Maintenance Counter Reset will display the last 10 items that have been reset.

Parts History in Time Series

❖ Function

- Display the latest 50 items of the Maintenance Counter Reset History.

❖ Purpose

- Check the maintenance frequency for each part.

❖ Items

- No.
(Number of the special Parts Counter)
- Parts Name
- P/N
- Counter/Limit
- Replacement Count
- ORU
("*" display means that the part is replaced in the ORU-M mode.)

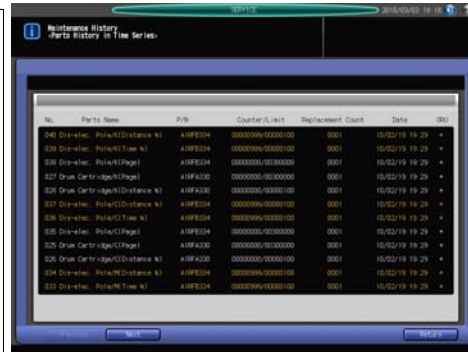

No.	Parts Name	P/N	Counter/Limit	Replacement Count	Date	ORU
046	Drum-Relace (Distance N)	A18F824	5000000/5000000	5001	10/02/19 19:29	*
038	Drum-Relace (Time N)	A18F824	5000000/5000000	5001	10/02/19 19:29	*
036	Drum-Relace (Page)	A18F824	5000000/5000000	5001	10/02/19 19:29	*
027	Drum Cartridge (Page)	A18F430	5000000/5000000	5001	10/02/19 19:29	*
026	Drum Cartridge (Distance N)	A18F430	5000000/5000000	5001	10/02/19 19:29	*
027	Drum-Relace (Distance N)	A18F824	5000000/5000000	5001	10/02/19 19:29	*
026	Drum-Relace (Time N)	A18F824	5000000/5000000	5001	10/02/19 19:29	*
025	Drum-Relace (Page)	A18F824	5000000/5000000	5001	10/02/19 19:29	*
025	Drum Cartridge (Page)	A18F430	5000000/5000000	5001	10/02/19 19:29	*
026	Drum Cartridge (Distance N)	A18F430	5000000/5000000	5001	10/02/19 19:29	*
024	Drum-Relace (Distance N)	A18F824	5000000/5000000	5001	10/02/19 19:29	*
022	Drum-Relace (Time N)	A18F824	5000000/5000000	5001	10/02/19 19:29	*

NARRATION:

The Parts History in Time Series Counter will display the last 50 items that have been replaced to be able to check the maintenance frequency for each of the parts listed.

ORU-M Maintenance History

❖ Function

- Display the information of the ORU-M Maintenance History
- Display the information for each ORU-M Maintenance Unit
- Display the information of ORU-M Maintenance Total

❖ Purpose

- Check the frequency of the Unit Replacement, then forecast the timing of replacing the ORU Target Part and collect each units type of information.

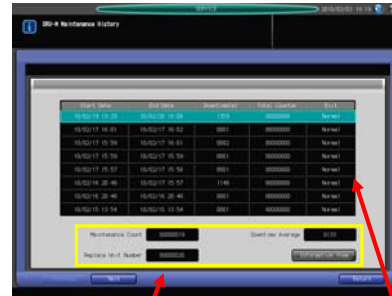

ORU-M Maintenance History Total Information	ORU-M Maintenance History Information
---	---------------------------------------

NARRATION:

The New ORU-M Maintenance History displays when the customer has replaced the ORU-M Items. This will allow you to be able to forecast when a replacement should be ordered to have on hand for the customer to replace.

Custom Counter Threshold Set

❖ Function

- Set the Custom Size Paper Length Threshold in the Sub Scan Direction for Paper Size Counter (Total/Copy/Printer)

NOTE

- This setting is enabled when DIPSW8-7=1.
- Set the Setting Value as following.
Infinite1<Infinite2<Infinite3<Infinite4

NARRATION:

The setting of the Custom Counter Threshold Setting allows for the setting of custom size paper lengths in the Sub Scan Direction for the Paper Size Counter, when Dip Switch 8-7 is set to a 1.

Maintenance Counter and Total Counter

❖ Function

- Total Counter
 - The condition of Large Size Paper for (2 counts) and small size can be changed by DIPSW's 33-2/3.
 - The counting condition of Color and Black-and-White can be changed by DIPSW's 30-0 and 30-1.
- Maintenance Counter
 - The condition of Large Size and Small Size paper cannot be changed.
 - The setting of Double-Count by Size cannot be changed.
→ Switch 2 counts and 1 count according to the predetermined paper size.

NARRATION:

The Total Counter and Maintenance Counters can be set for certain conditions of which paper sizes are used to better reflect the actual consumables and parts life.

Maintenance Counter and Total Counter

❖ Counting Condition of Maintenance Counter

- Finite size

- Small Sizes (1 count)

SRA4S	320 mm
8.25 x 13	330 mm
8 x 13	330 mm
8.5 x 13	330 mm
8.125 x 13.25	336 mm

- Large Sizes (2 counts)

8.5 x 14	355 mm
B4	364 mm
8K	390 mm
A3	420 mm
11 x 17	432 mm

- Infinite Size (this count is enabled by Dipswitch 8-7)

- Count the threshold of 338 mm (13.307 inches) or more as a Large Size

NOTE: The counting condition cannot be changed.

NARRATION:

To determine Large Sizes from Small sizes of paper, anything 338 millimeters or larger should be set as a Large Size Paper.

3.10 Others

- Main Differences
- I/O Check Mode Operation "Hard Disk Drive Replacing Procedure"
- Test Pattern No.49 RU Color Sensor gamma Correction
- Test Pattern No.75 Density Correction Pattern i1-iSis XL
- Test Pattern No.76 Density Correction Pattern i1-Pro (Type1)
- Test Pattern No.76 Density Correction Pattern i1-Pro (Type2)
- Test Pattern No.77 Density Correction Pattern Manual
- Setting Data
- Log Store
- ORU-M Settings

NARRATION:

The following information will be covered in this section.

Main Differences

Items	C7000/C7000P/C6000	C6501/C6501P/C65hc	Details
I/O Check Mode Operation "Hard Disk Drive Replacing Procedure"	An Abnormal HDD is determined according to the Corresponding Malfunction Code.	The abnormal HDD is determined by the Rest Mode IO99-04	-
Test Patterns	Patterns for the Density Balance Adjustment and Output Paper Density Adjustment were added, Codes for Chart File Output were added	-	-
Setting Data	New Addition	-	Same level as the PRO1200
Log Store	New Addition	-	Set the Log Storing Method/Log Storing Destination for Troubleshooting
ORU-M Setting	New Addition	-	Set the ORU-M Target Unit and the Life Yields.

NARRATION:

This chart details the additional changes for the C7000.

I/O Check Mode Operation "Hard Disk Drive Replacing Procedure"

❖ HDD Replacing Procedure

C7000

- The Abnormal HDD can be determined by the following Malfunction Codes.

- C-D0E3 Y
- C-D0E4 M
- C-D0E5 C
- C-D0E6 K
- C-D0E7 A
- C-D0E8 P

C6501/C6501P/C65hc/C5501

- The Abnormal HDD can be determined according to the I/O Check Mode (IO99-04).
The check of the Abnormal HDD is displayed on the Input Check Area in the order Y, M, C, then K.
Example) oxox = M and K are abnormal

(Normal= o Abnormal= x Not connected= -)

NARRATION:

The Malfunction Codes for the determination of which Hard Disk Drive have been expanded to identify which of the 6 drives are either defective or not installed.

Test Pattern No.49 RU Color Sensor gamma Correction

❖ Purpose

- Used for the "Output Paper Density Adj." in User Mode.
- A test pattern used for registering the paper category in the "Output Paper Density Adj."

NOTE:

This Test Pattern generates 3 different types for each size.

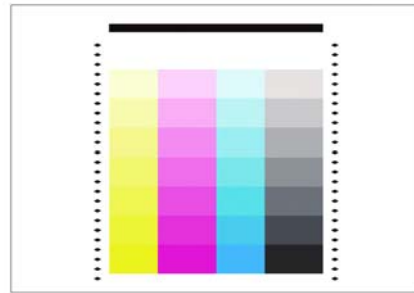

NARRATION:

The Test Pattern Number 49 is used with the RU-509 Color Sensor gamma Correction. These Test Patterns are generated from the User Mode and is used to register the different Paper Categories for the Output Paper Density Adjustment.

Test Pattern No.75 Density Correction Pattern i1-iSis XL

❖ Purpose

- A Test Pattern is output by the Density Balance Adjustment Chart from the User Mode (When Calibrating using i1-iSis XL).



NARRATION:

Density Correction Pattern Number 75 is output to calibrate the C7000 when using the i1-iSis XL from the User Mode.

Test Pattern No.76 Density Correction Pattern i1-Pro

❖ Purpose

- A Test Pattern is output by the Density Balance Adjustment Chart from the User Mode (When Calibrating using i1-Pro).

[Type 1]

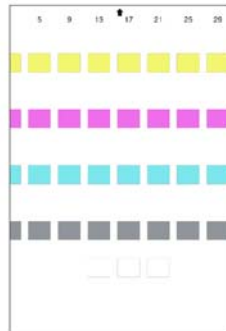

[Type 2]

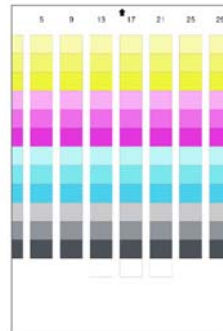

NARRATION:

Density Correction Pattern Number 76 is output to calibrate the C7000 when using the i1-Pro from the User Mode.

Test Pattern No.77 Density Correction Pattern Manual

❖ Purpose

- A Test Pattern is output by the "Output Paper Density Manual Adj." in the User Mode (When using the Manual Adjustment).

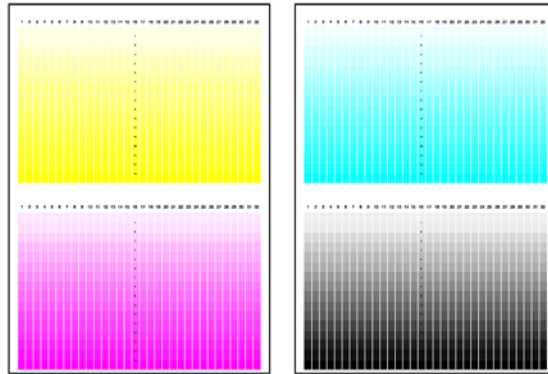

NARRATION:

Density Correction Pattern Number 77 is output to calibrate the C7000 when using the Manual Adjustment from the User Mode.

Setting Data

❖ Setting Data

Function Image



- Paper Setting Data
- Setting Menu Data
- Software DIPSW Setting Data
- CSRC Setting Data



Service Port

Function Purpose

- When installing the Main Body (Import the Setting Values that the User requests prepared in advance)

[Setting Data](#) 

NARRATION:

Information can be saved to USB Memory from one machine and then written on a new machine being set up in advance to the customers values.

Log Store

❖ Function

- Store the Log Automatically when Malfunction Code occurs.
- Store the Log Manually at arbitrary timing.

❖ Purpose

- For Troubleshooting.

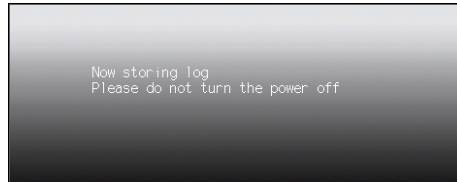

NOTE:

The destination to store can be selected from the HDD or the USB Device.

[Log Store](#) 

NARRATION:

The Log can automatically store any malfunction codes and at any time the log can be set to store this data manually, which is handy when you are troubleshooting the equipment. You can also select whether to store the log to the Hard Disk Drive or to a USB Memory Device.

ORU-M Setting

❖ Function

- Set the ORU-M Target Units and the life of those units.

NOTE:

This setting cannot be selected if the ORU-M is not enabled.
(Default setting is disabled.) To enable the ORU-M, set the DIPSW15-0=1.



[ORU-M Setting](#)



NARRATION:

You also have the capability to set the ORU-M Target Units and the life of those units.

3.10 Appendix

- ❖ [Software DIPSW List](#) 
- ❖ [Adjustment Item List](#) 
- ❖ [Service Mode List](#) 

NARRATION:

Here are links to the service manual data for the software DIP Switches, adjustment items, and service mode lists.

3.10 Lesson 3 Review

Lesson 3

In this Lesson, you learned about:

- | | |
|---------------------------|--------------------|
| 3.1 Maintenance | 3.7 Software DIPSW |
| 3.2 Service Tool | 3.8 Job History |
| 3.3 Rewriting of Firmware | 3.9 Others |
| 3.4 Trouble Shooting | 3.10 Appendix |
| 3.5 Machine Adjustments | 3.11 Lesson Review |
| 3.6 Process Adjustments | |

Narration:

In this lesson, you learned about some of the Main Differences and New Adjustments for the bizhub PRESS C7000 Series.

Lesson 4 : ORU-M

Topics covered in the lesson include:

- | | | | |
|-----|---|------|-------------------------------|
| 4.1 | What is ORU-M? | 4.9 | What a CE does... |
| 4.2 | ORU-M Target Unit | 4.10 | Workflow of ORU-M Maintenance |
| 4.3 | How to enter the ORU-M Mode? (DIPSW Settings) | 4.11 | Preparing USB Memory |
| 4.4 | ORU-M Main Screen | 4.12 | Rewriting ORU-M Counter |
| 4.5 | ORU-M Replacement Work Screen | 4.13 | Management Tool |
| 4.6 | Outline of C7000 ORU-M | 4.14 | ORU-M Developing Unit |
| 4.7 | Administrator and Technician | 4.15 | Lesson Review |
| 4.8 | Service Mode Items related to ORU-M | | |

NARRATION:

The following topics will be covered in this lesson.

4.1 What is ORU-M?

❖ C7000/C7000P/C6000/C70hc

Purpose of ORU-M (Operator Replaceable Unit Management)

- ORU-M is a system to help customers to replace the units of the machine by themselves.
- Intends to shorten the downtime of the machine
 - * The replacement procedural guide is displayed on the Operation Panel and is available for reference during replacement of the units

NARRATION:

What is ORU-M? ORU-M is defined as Operator Replaceable Unit Management and is intended to allow the Customers to replace certain units of the machine themselves to shorten the downtime of the System.

4.2 ORU-M Target Units

❖ C7000/C7000P/C6000/C70hc

12 ORU-M Target Units



NARRATION:

There are 12 target units that can be tracked and replaced under the ORU-M Function for the bizhub PRESS C7000 Series.

4.3 How to enter the ORU-M Mode? (DIPSW Setting)

❖ C7000/C7000P/C6000/C70hc

Entering Method to access ORU-M Mode → Customer Engineer Setting

- DIPSW setting 15:0:ON (1)

* Press Utility/Counter Key to display the ORU-M Screen.



* Press ORU-M Key to enter the ORU-M Work Screen.

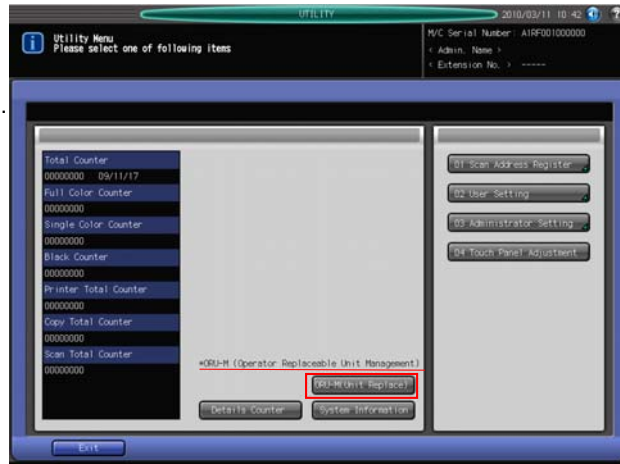

NARRATION:

To enter the ORU-M Mode, first you must change DIP SWITCH 15:0 to a 1.

Next, press the Utility/Counter Key to display the ORU-M Mode Key on the Utility/Counter Screen.

Then, press the ORU-M Mode Key to display the ORU-M Mode Work Screen.

4.4 ORU-M Main Screen

❖ C7000/C7000P/C6000/C70hc

Menu

- **Sample Output Key**
 - 2 types of samples
- **Print Mode Key**
 - Printout available
- **Replacement Procedure**
 - Procedure can be referred on the Operation Panel during operation. Operation Panel is kept ON.
- **Start Replacement Key**
 - The Power Supplies other than for the Operation Panel are cut off automatically. They automatically recover after completion of the operation and start each adjustment.

ORU-M Mode Main Screen



NARRATION:

Here we see the Main Screen for the ORU-M. The Operation Panel will display the information needed to assist the Operator in the replacement of the unit. The Power Supplies other than the one for the Operation Panel are turned off and after the unit is replaced and the interlocks closed, any necessary adjustments will begin automatically if needed.

4.5 ORU-M Replacement Work Screens (1/7)

❖ Conduct the Sample Output before the Replacement Work.

Press Sample Output Key on the screen shown on the previous slide. → Type1 Key → Return Key → Print Mode Key → Print → Exit Print Mode Key (Print the sample of Type 2 in the same way) *Compare the Output Samples after Unit Replacement.

Sample Type Screen

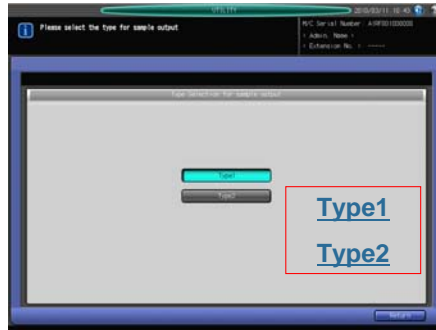

Print Screen



NARRATION:

One of the first ORU-M Screens is the Sample Output Screen, where you should print out samples to compare with a set you will print out after you replace the units in question.

4.5 ORU-M Replacement Work Screens (2/7)

❖ ORU-M Main Screen → Start Replacement Key

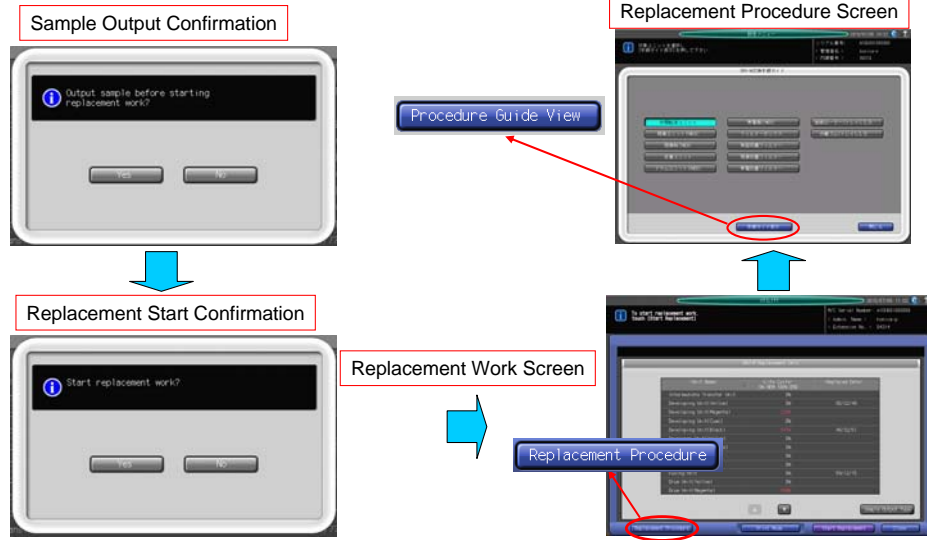

NARRATION:

The next screens will cycle thru the steps from Sample Output Confirmation, Replacement Start Confirmation, the Replacement Work Screen and then the Replacement Procedure Screen.

4.5 ORU-M Replacement Work Screens (3/7)

❖ Replacement Procedure Screen



1. The procedures can be checked on the Operation Panel during operation.
2. The next step appears every time [➡] is pressed.
3. Press [Close] Key to return to the previous screen.

NARRATION:

The Replacement Work Screens will walk the user thru the steps to replace the selected unit.

4.5 ORU-M Replacement Work Screens (4/7)

❖ [Replacement Procedure Screen] → [Check Screen]

- When the [Check] Key is displayed on the Procedure Guide Screen, pressing it displays a Sub Screen of precaution.
- Press [Close] Key to return to the Procedure Guide Screen.

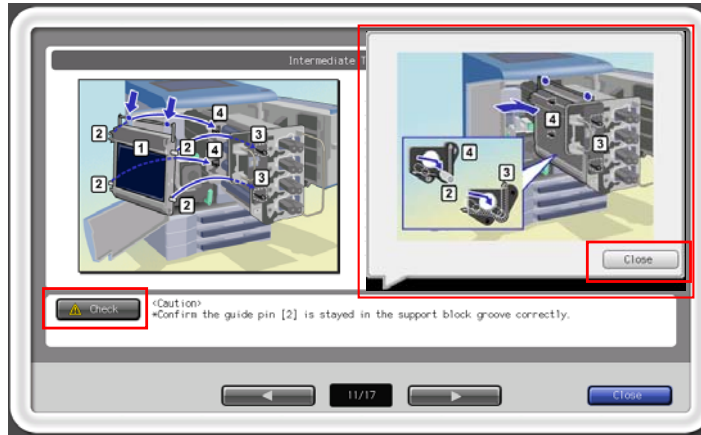

NARRATION:

When the Check Key is displayed during the Replacement Procedure Screens, by pressing this key, important precautions will be displayed on a sub screen.

4.5 ORU-M Replacement Work Screens (5/7)

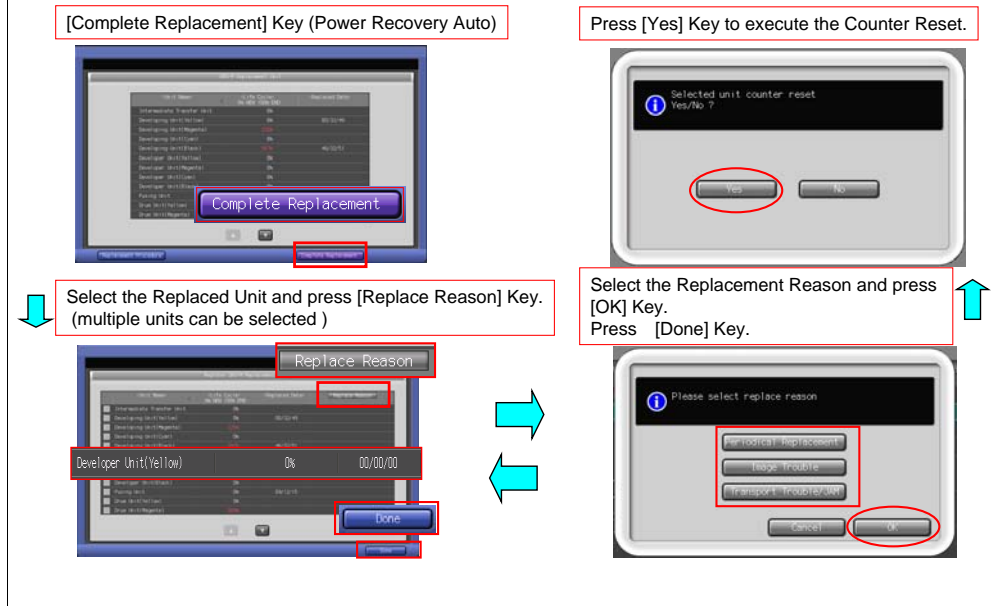

NARRATION:

The next screens will confirm you have completed the replacement unit or multiple units. Then you will press the Replace Reason Key and select why the units were replaced. Finally you must confirm that you want to reset the counter for the units replaced.

4.5 ORU-M Replacement Work Screens (6/7)

❖ Adjustment After Unit Replacing Screen



The adjustment items are different depending on which Units were changed.

* Output a sample to compare it with the one before the replacement

NARRATION:

After confirming the Counter Reset, the Adjustment Screen will appear and depending on what units were replaced, a series of adjustments will be automatically performed. After this step, print out the sample copies after the units were replaced for comparison.

4.5 ORU-M Replacement Work Screens (7/7)

❖ Operation is completed with this screen

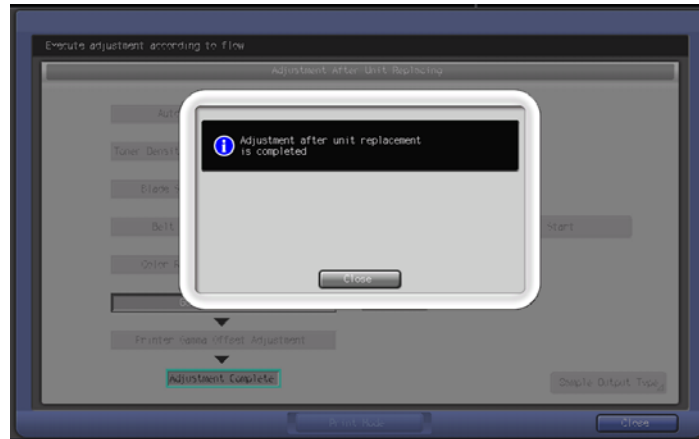

NARRATION:

When all the adjustments have been performed, this screen should be displayed, to confirm the replacement operations have been completed properly.

4.6 Outline of the C7000 ORU-M

❖ Outline

- In the C7000 Series, Counter Data is managed by using USB Memory
- USB Memory is needed for the CE to manage the Counter Data
- Transfer the Counter Data of the Fusing Unit and Intermediate Transfer Unit from the Main Body to the USB Memory
- In the C7000, 1 set (Fusing Unit/Intermediate Transfer Unit) of Spare Unit is recommended per 1 Main Body

**It is NOT recommended to use Several Spare Units on a device.
Be sure to use only 1 set of Spare Units for a device.**

NARRATION:

The C8000 Counter Data is managed by the use of RFID Transmitters. The C7000 Series Counter Data is managed by the use of USB Memory since C7000's ORU-M Units are not equipped with the RFID Tags.

4.7 Administrator and Technician

❖ Login User

1. Administrator is...Service Manager
2. Technician is... CE who actually performs the maintenance

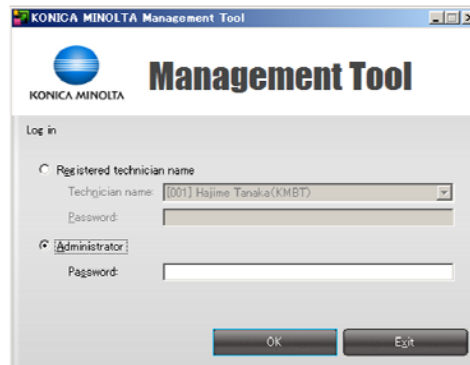

NARRATION:

The Konica Minolta Management Tool has two different levels of Log In capabilities. For the Administrator, which is usually the Service Manager, and the other for the Registered Technician or Customer Engineer that is certified on the product.

4.8 Service Mode Items related to the ORU-M

Item	C7000/C7000P/C6000	C8000	Details
Counter Data Management between Main Body and Management Tool	Acquiring/Rewriting Counter by USB (Intermediate Transfer Unit/Fusing Unit)	RFID (RFID corresponding unit)	-
Counter/Data	ORU-M Maintenance History	<ul style="list-style-type: none"> ▪ Display the information of the ORU-M Maintenance History ▪ Display the information of each ORU-M Maintenance Unit ▪ Display the information of the ORU-M Maintenance Total 	Refer to: ORU-M Maintenance History
List Output	ORU-M Maintenance History	-	Output List was added
Software DIPSW	DIPSW 15-0 ORU-M Operator Release Setting	Switching ORU-M unavailable or available	Refer to: DIPSW 15-0 ORU-M Operator Release Setting
	DIPSW 16-7 ORU-M Developing Unit Counter Setting	User can enter the Life Counter (distance and quantity) of the Developing Unit.	Refer to: DIPSW 16-7 ORU-M Developing Unit Counter Setting
ORU-M Setting		Set the ORU-M Target Unit and the Yield.	Refer to: ORU-M Setting

NARRATION:

This table covers the other main differences of the service mode covering the ORU-M Mode.

4.9 What CE does...

❖ CE Operation

1. Set the Software DIPSW15-0 to 1 (ON).
2. Set the ORU-M Target Unit to [Enable].
3. Install the Management Tool on the computer.
4. Register information that is required for the Management Tool.
(Such as User Information/Technician Information/Administrator Information)
5. Check the Parts Count with the Management Tool and replace the Units which need to be replaced.
6. Store the Replacement Units at the Customer's Location.

NARRATION:

The following steps detail what the Technician will perform when ORU-M is to be enabled.

4.10 Flow of ORU-M Maintenance

- [1] Save the Counter Data of the Unit after the replacement in the USB Memory
("Store to External Memory" in ORU-M Counter Rewriting)
- [2] Check the Counter with Management Tool
- [3] Replace the part
- [4] Reset the Counter Data in the USB Memory
- [5] Reset the Counter of the Main Body
("Load from External Memory" in ORU-M Counter Rewriting)

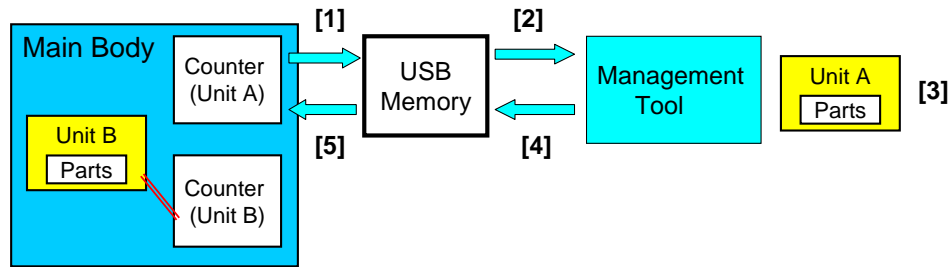

NARRATION:

Shown here is the flow of the data for the ORU-M Maintenance Steps.

4.11 Preparing USB Memory

❖ Be sure to create a folder in the USB Memory as shown in the picture below.

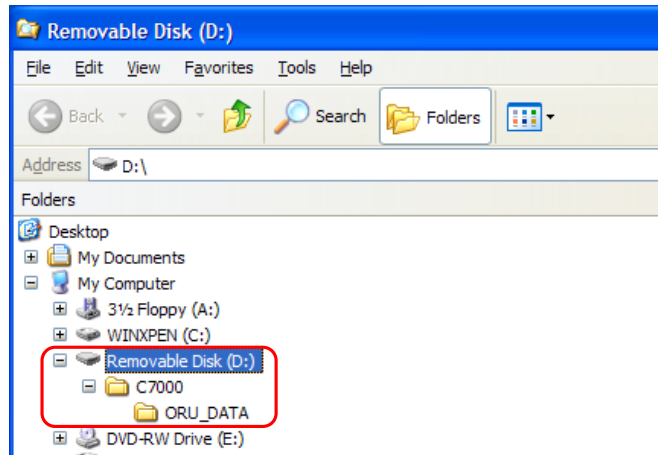

NARRATION:

To export/import the counter data and manage it with the Management Tool, be sure to create the specified folder in the USB Memory Device before use.

4.12 Rewriting ORU-M Counter

- ❖ To rewrite the Counter for the Spare Unit, enter the New Hidden Sequence from Utility.

New Hidden Sequence: 1 → 0 → C → 6 → 9

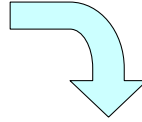

Counter Data can be rewritten even during printing operations

NARRATION:

To rewrite the Counter for a Unit that is going to be replaced, you must enter a New Hidden Sequence, 1 – 0 - C – 6 – 9, from the Utility Screen.

To reduce the down time, the counter data can be rewritten even during printing.

4.13 Management Tool

This is a software to read and reset the discrete part counter information inside the [unit that is stored in the RFID* and USB Memory](#) of the ORU-M Target Unit.

❖ Function

- Reading/writing RFID Tag of Unit (Only for the C8000)
- Work Usage Log Management
- Outputting Work Usage Information in a CSV File
- Printing Work Usage Information
- Association of User and Device
- Export/Import
- Unit Serial Number Setting

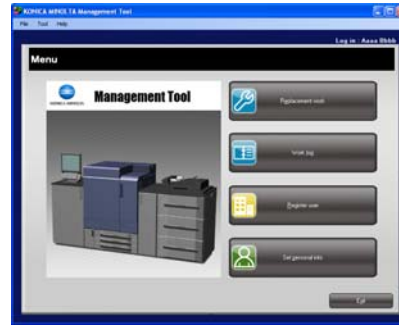

* [RFID tag is mounted on the C8000 Intermediate Transfer, 2nd Transfer, Fusing Unit, and 2nd Fusing Unit in the RU-508.](#)

[Management Tool](#) 

NARRATION:

Management Tool is software that is used to read and reset the discrete part counter information.

4.14 ORU-M Developing Unit (1/2)

❖ When the Developing Unit is replaced

- 2 Developing Units can be registered for a single Main Body.
- The Life of the Developing Unit is 1,020,000 prints for the C7000, and 900,000 prints for the C6000. After the removal of the Developer Unit A, install the New Developer Unit B. (Developing Unit A/ Developing Unit B)

Until it reaches the Life of the Developing Unit, use the in-use Developing Unit A and the Spare Developing Unit B alternately.

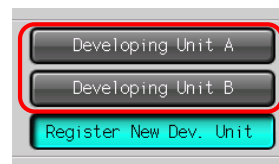

NARRATION:

Two Developer Units can be registered for a single Main Body. This is performed by the use of separate Developer Unit A and B Counters that are used alternately when switching between the two units.

4.14 ORU-M Developing Unit (2/2)

❖ When the Developing Unit is replaced

When using 3 or more Developing Units, a screen to enter the Developing Unit Life in the ORU-M mode is displayed by setting the Software DIPSW 16-7 to 1.

→ In this case, the operator needs to manage the life of the Developing Units.

NOTE: The replacement of the Developer is essential when the Developing Unit is replaced.

NARRATION:

If more than three or more Developing Units are used to maintain the machine, Software Dip Switch 16-7 should be set to a 1. When accounts use this method of maintaining multiple Developer Units, the Operator must keep track of the counter information for each of the units themselves.

4.11 Lesson 4 Review

Lesson 4

In this Lesson, you learned about:

- | | | | |
|-----|---|------|-------------------------------|
| 4.1 | What is ORU-M? | 4.9 | What a CE does... |
| 4.2 | ORU-M Target Unit | 4.10 | Workflow of ORU-M Maintenance |
| 4.3 | How to enter the ORU-M Mode? (DIPSW Settings) | 4.11 | Preparing USB Memory |
| 4.4 | ORU-M Main Screen | 4.12 | Rewriting ORU-M Counter |
| 4.5 | ORU-M Replacement Work Screen | 4.13 | Management Tool |
| 4.6 | Outline of C7000 ORU-M | 4.14 | For Developing Unit |
| 4.7 | Administrator and Technician | | |
| 4.8 | Service Mode Items related to ORU-M | | |

Narration:

In this lesson, you learned about the Basic Specifications of the bizhub PRESS C7000 Series.

Course Completion

Congratulations, you have completed the bizhub PRESS C7000/C700P/C6000 Differences Training Course for the Engine Module.

After reviewing this course you should now have a good understanding of the following Lessons:

Outline
Configuration/Operation
Field Service
ORU-M

NARRATION:

Congratulations, You have completed the bizhub PRESS C7000/C7000P/C6000 Web Based Differences Training Course for the Engine Module.

After reviewing this course you should now have a good understanding of the following Lessons: Outline, Configuration/Operation, Field Service and the ORU-M.